



A woman with long dark hair, seen from the side, is sitting on a large, white ice floe. She is looking down and to the right. The background is a vast, cold landscape with many other ice floes floating in a body of water under a pale, overcast sky. The overall color palette is dominated by blues and whites, creating a serene and chilly atmosphere.

Casting

Hair Beauty & Wellness

L'essenza del benessere

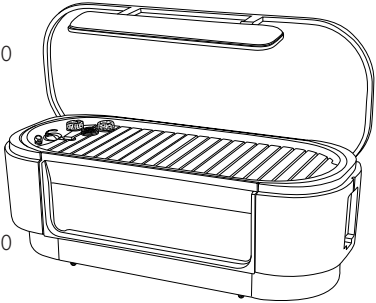
Byzantium

	ART.	Descrizione	Description	Kg.	m ³	Cat.	Euro
L 100 P 215 H 70/90		3510 Letto termale polifunzionale che consente una vasta gamma di trattamenti che richiedono l'acqua fredda e calda. Il letto è completo di doghe in legno, doccia e kit di spugne per la cura del corpo, docce viki e scozzese, cromoterapia	<i>Multifunction coach for water treatments. The coach is provided of a wood mattress, shower and kit of sponges for body-care, viki and scottish showers, chromotherapy led system</i>	180	2,30		13.500,00
			3511 Letto termale polifunzionale regolabile in altezza che consente una vasta gamma di trattamenti che richiedono l'acqua fredda, calda e il vapore. Il letto è completo di materasso ad acqua, doghe in legno, doccia e kit di spugne per la cura del corpo, bagno di vapore, docce viki e scozzese, nebulizzatore, cromoterapia e musicoterapia	<i>Multifunction coach for water treatments. Adjustment of height by two synchronized electric motors, remote controlled. The coach is provided of a water mattress and a wood mattress, shower and kit of sponges for body-care, steam system, viki and scottish showers, nebulizer, chromotherapy led system and music therapy</i>	180	2,30	
		3512 Sistema per la regolazione dell'altezza con 2 motori elettrici sincronizzati controllati a distanza	<i>Adjustment of height by two synchronized electric motors, remote controlled</i>				1.700,00
		3513 Generatore di vapore munito di tenda in nylon impermeabile	<i>Steam system with water-proof nylon cover</i>				1.200,00
		C3513 Tenda in nylon impermeabile di ricambio (ricambio)	<i>Water-proof nylon cover (refill)</i>				145,00
		3514 Sistema di nebulizzazione	<i>Nebulization system</i>				1.350,00
		3515 Pompa con inverter per garantire la pressione dell'acqua (obbligatoria con sistema di nebulizzazione)	<i>Water pump (required for nebulization system)</i>				1.850,00
		3516 Scalda acqua con filtraggio dell'acqua	<i>Water heater with water filtration</i>				900,00
		3517 Materasso ad acqua con sistema di riempimento	<i>Water mattress with filling system</i>				700,00
		3518 Musicoterapia	<i>Music therapy</i>				300,00
		3457 Kit 3 Spugne body-care	<i>Kit 3 sponges body-care</i>				45,00



Creta

L 75
P 208
H 81

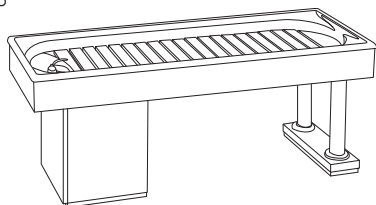

3450 Letto professionale con doghe in legno, vasca in metacrilato, doccia e kit di spugne per la cura del corpo, struttura in ferro zincato rivestita in nobilitato.

Professional couch with wood mattress, methacrylate basin, shower and kit of sponges for body-care. Galvanized iron structure covered with laminated wood.

Kg. m³ Cat. Euro

80

3.300,00



Creta vapore

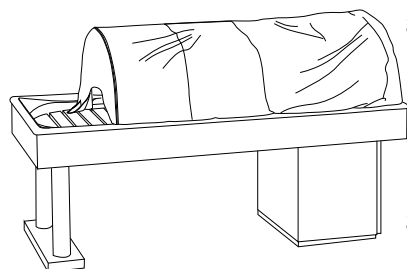

3460 Letto professionale con doghe in legno, vasca in metacrilato, doccia e kit di spugne per la cura del corpo, bagno di vapore, struttura in ferro zincato rivestita in nobilitato.

Professional couch with wood mattress, methacrylate basin, shower and kit of sponges for body-care and steam system. Galvanized iron structure covered with laminated wood.

Kg. m³ Cat. Euro

4.500,00

3461 Musicoterapia

Music therapy

300,00

Creta accessori

M3450 Materasso con fodera in skay imbottito con poliuretano espanso

Mattress with skay cover and polyurethane stuffing

Kg. m³ Cat. Euro

B 300,00

C 250,00

C3455 Tenda in nylon impermeabile di ricambio (ricambio).

Water-proof nylon cover (refill).

145,00

3457 Kit 3 Spugne body-care

Kit 3 sponges body-care

45,00



Aquaria Plus

L 76
P 206
H 70/90

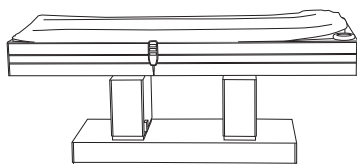

3415 Sistema di regolazione mediante motori elettrici della posizione della testa e dei piedi. I due snodi sono indipendenti. L'escursione è limitata per consentire il massimo comfort del materasso ad acqua appositamente realizzato in tre sezioni. Cromoterapia

Electrical control system of 2 independent lifting position for head and leg rest. The range of movement is moderate to offer the best comfort of the waterbed mattress, suitably made of three parts. Chromotherapy

Kg. m³ Cat. Euro

120

9.700,00

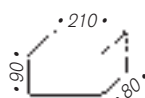

Aquaria

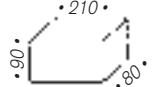
	ART.	Descrizione	Description	Kg.	m ³	Cat.	Euro
L 76 P 206 H 70/90	3400	Letto professionale con materasso ad acqua riscaldato. Struttura in ferro zincato rivestita in legno listellare impiallacciato rovere verniciato nei colori di catalogo. Il letto è regolabile in altezza mediante due motori elettrici sincronizzati e comandati da una pulsantiera. Sia l'operatore che il cliente non sono in nessun caso a contatto con l'acqua. La temperatura dell'acqua è regolabile. Il letto è fornito di sistema per il riempimento del materasso. Cromoterapia	<i>Professional couch with heated waterbed mattress. Galvanized iron structure covered with oak veneer wood available in all catalogues colours. Adjustment of height by two synchronized electric motors, remote controlled by push button panel. Both the operator and the customers are never in contact with water. Water temperature is adjustable. A system for filling the mattress is included. Chromotherapy</i>	110			8.600,00
							

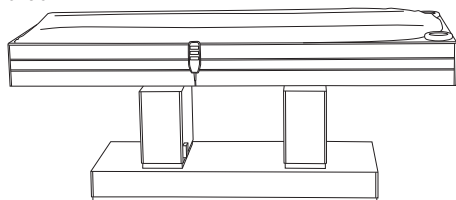

Aquaria Basic

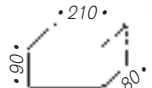
	ART.	Descrizione	Description	Kg.	m ³	Cat.	Euro
L 76 P 206 H 79	3420	Letto professionale con materasso ad acqua riscaldato. Struttura in legno listellare impiallacciato rovere verniciato nei colori di catalogo. Sia l'operatore che il cliente non sono in nessun caso a contatto con l'acqua. La temperatura dell'acqua è regolabile. Il letto è fornito di sistema per il riempimento del materasso. Cromoterapia	<i>Professional couch with heated waterbed mattress. Oak veneer wood structure available in all catalogues colours. Water temperature is adjustable. Both the operator and the customers are never in contact with water. A system for filling the mattress is included. Chromotherapy</i>	90			5.900,00
							

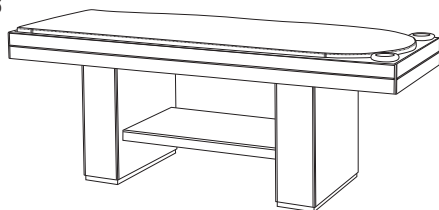

Aquaria Essential

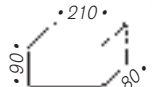

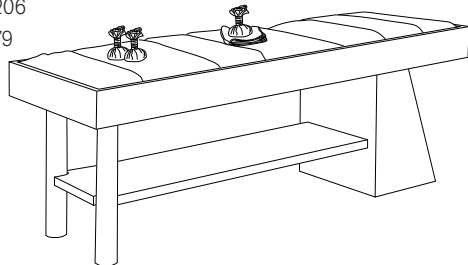
	ART.	Descrizione	Description	Kg.	m ³	Cat.	Euro
L 76 P 206 H 79	3430	Letto professionale con materasso ad acqua riscaldato (3 pezzi). Struttura in ferro zincato rivestita in nobilitato. Sia l'operatore che il cliente non sono in nessun caso a contatto con l'acqua. La temperatura dell'acqua è regolabile. Il letto è fornito di sistema per il riempimento del materasso. Cromoterapia	<i>Professional couch with heated waterbed mattress (3 pieces). Galvanized iron structure covered with laminated wood. Water temperature is adjustable. Both the operator and the customers are never in contact with water. A system for filling the mattress is included. Chromotherapy</i>	90			3.200,00
							

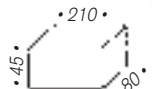

Aquaria Relax

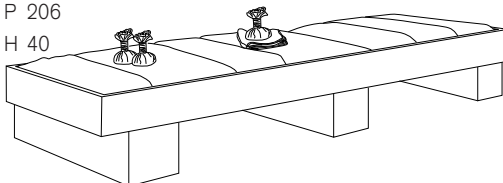
	ART.	Descrizione	Description	Kg.	m ³	Cat.	Euro
L 76 P 206 H 40	3435	Letto professionale con materasso ad acqua riscaldato (3 pezzi). Struttura in legno rivestita in nobilitato nei colori di catalogo. Sia l'operatore che il cliente non sono in nessun caso a contatto con l'acqua. La temperatura dell'acqua è regolabile. Il letto è fornito di sistema per il riempimento del materasso. Cromoterapia	<i>Professional couch with heated waterbed mattress (3 pieces). Wood structure covered with laminated wood in catalogues colours. Water temperature is adjustable. Both the operator and the customers are never in contact with water. A system for filling the mattress is included. Chromotherapy</i>	65			2.700,00
							

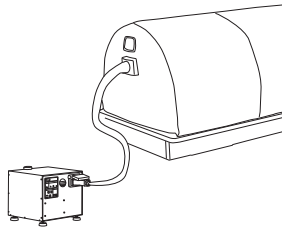
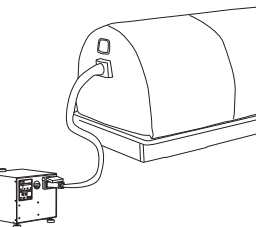
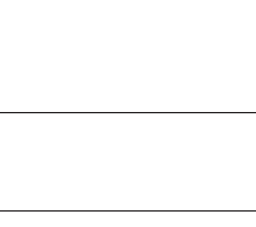
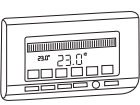
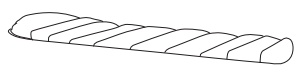

Aquaria accessori		ART.	Descrizione	Description	Kg.	m ³	Cat.	Euro
	3405	Generatore ad alta prestazione. La sonda all'interno della capottina consente di mantenere la temperatura pre-impostata costante. Il serbatoio dell'acqua è ricaricabile anche durante il trattamento.	<i>High performance generator. A probe inside the canvas hood allows to keep the pre-settled temperature always constant. The water tank can be refilled also during the treatment.</i>					2.380,00
	A3405	Aromaterapia	<i>Aromatherapy</i>					1.070,00
	3406	Generatore senza pompa di ricarica. Il serbatoio consente di effettuare oltre 90 minuti di trattamenti prima della ricarica e non è ricaricabile durante i trattamenti.	<i>Steam system. Steam generator without refill pump. The tank allows to make more than 90 minutes of treatments before refilling it during the treatment.</i>					2.380,00
	C3405	Tenda in nylon impermeabile di ricambio (ricambio).	<i>Water-proof nylon cover (refill).</i>					145,00
	C3406	Tenda in nylon impermeabile di ricambio abbinato al sistema per aromaterapia.	<i>Water-proof nylon cover (refill) for aromatherapy.</i>					145,00
	3407	Sistema di controllo avanzato (il tempo di accensione e spegnimento del sistema di riscaldamento è programmabile giornalmente e settimanalmente)	<i>Advanced control system (the switch on/off of heating system can be setted daily and weekly)</i>					160,00
	3402	Copertura termica per Aquaria	<i>Thermic cover for Aquaria</i>					100,00
	3403	Materasso ad acqua 3 pezzi	<i>Water mattress (3 pieces)</i>					460,00
	M3420	Materasso ad acqua intero	<i>Water mattress (1 piece)</i>					390,00
	M3430	Materasso imbottito con rivestimento in skay	<i>Latex mattress covered with skay</i>				B	300,00
							C	250,00
	3408	Musicoterapia	<i>Music therapy</i>					300,00
	3409	Liquido igienizzante (1 l)	<i>Sanitizing liquid (1 l)</i>					6,50

Himalaya

	ART.	Descrizione	Description	Kg.	m ³	Cat.	Euro
L 76 P 206 H 79	3440	Letto professionale per Haloterapia con materasso riscaldato imbottito di sale e panetti di cristalli di sale dell'Himalaya. Struttura in ferro zincato rivestita in nobilitato. La temperatura del materasso è regolabile. Cromoterapia	Professional couch for Halotherapy with heated salt filled mattress and Himalaya salt crystals. Galvanized iron structure covered with laminated wood. Mattress temperature is adjustable. Chromotherapy	170			3.400,00

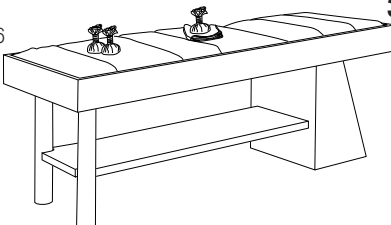
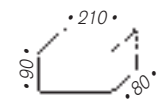



M3440	Materasso imbottito con rivestimento in skay	Latex mattress covered with skay	B	300,00
			C	250,00

A3440	Materasso ad acqua con pompa per riempimento (3 pezzi)	Water mattress (3 pieces) with system for filling the mattress		390,00
--------------	--	--	--	---------------

Aura

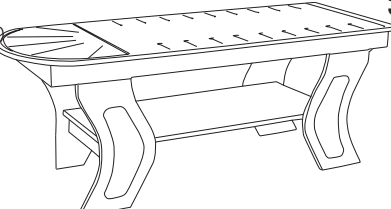
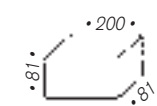
	ART.	Descrizione	Description	Kg.	m ³	Cat.	Euro
L 75 P 200 H 75	3100	Letto professionale estremamente versatile, particolarmente adatto alla pratica ayurveda. È stato ideato per trattamenti con oli essenziali, bagni di vapore, aromaterapia e massaggi. Caratterizzato da un' struttura robusta e molto stabile (consegnato già montato), viene realizzato interamente in legno e verniciato negli 8 colori disponibili a catalogo.	Extremely versatile professional beauty couch, particularly suited to ayurvedic practices. Designed for treatments with essential oils, steam bath, aromatherapy and massages. Featuring a large-buid and firm structure (delivered already assembled) it's all made of wood and coated with solvent-free water-based varnish in the 8 colours available in the catalogue.	60	1,30		2.150,00



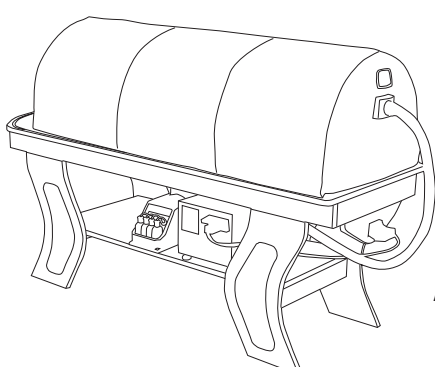

Aura vapore

	ART.	Descrizione	Description	Kg.	m ³	Cat.	Euro
	3173	Sistema Aura vapore. Generatore ad alta prestazione. La sonda all'interno della capottina consente di mantenere la temperatura pre-impostata costante. Il serbatoio dell'acqua è ricaricabile anche durante il trattamento.	Aura steam system. High performance generator. A probe inside the canvas hood allows to keep the pre-settled temperature always constant. The water tank can be refilled also during the treatment.	15	0,20		2.380,00
	3174	Sistema Aura vapore senza pompa di ricarica. Il serbatoio consente di effettuare oltre 90 minuti di trattamenti prima della ricarica e non è ricaricabile durante i trattamenti.	Aura steam system. Steam generator without refill pump. The tank allows to make more than 90 minutes of treatments before refilling it during the treatment.				2.380,00
	A3173	Sistema composto da 4 archi, realizzati in faggio verniciato resistente all'acqua, richiudibili per un ingombro minimo di 20 cm e una tenda in nylon impermeabile.	System composed by 4 arcs made of water-proof varnished beech, that can be closed in a minimum space of 20 cm., and of a nylon water-proof cover.	6	0,20		800,00
	C3173	Tenda in nylon impermeabile di ricambio per Aura (ricambio).	Water-proof nylon cover for Aura (refill).				145,00
	C3191	Tenda in nylon impermeabile di ricambio per Aura abbinato al sistema per aromaterapia.	Water-proof nylon cover for Aura (refill) for aromatherapy.				145,00
	3191	Aromaterapia per Aura	Aura aromatherapy				1.130,00

Aura olio

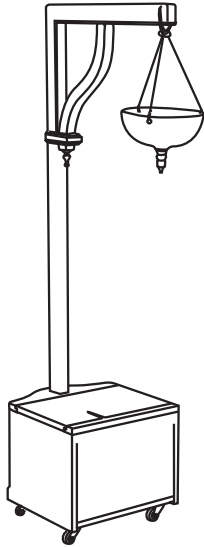
L 65
P 43
H 168



ART.	Descrizione	Description	Kg.	m ³	Cat.	Euro
3120	È stato studiato per il riscaldamento e la circolazione degli oli. La struttura contiene la macchina nell'apposito vano non a vista la macchina ci mantiene costante la temperatura dell'olio che viene fatto affluire direttamente alla ciotola attraverso un apposito condotto. Il flusso dell'olio può essere opportunamente regolato mediante rubinetto.	<i>Conceived for heating and spreading essential oils. A device, placed in a concealed compartment, keeps the oil to the fixed temperature and the oil flows directly into the bowl trough an oil duct. It's possible to control the oil flow with its tap.</i>	20			1.900,00
3121	Solo carrello con ciotola	<i>Only trolley with bowl.</i>				980,00
3122	Solo ciotola con rubinetto e attacco	<i>Only bowl.</i>				210,00
3123	Solo macchina.	<i>Only machine.</i>				920,00

Wood

L 73
P 195
H 75/85

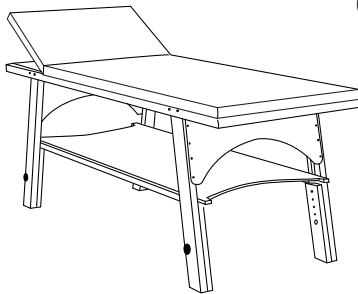

ART.	Descrizione	Description	Kg.	m ³	Cat.	Euro
083	Letto professionale di grande dimensione e portata, completamente realizzato in legno massello. Materasso con 1 snodo imbottito con poliuretano espanso (regolabile in altezza per cm 15). Completo di foro per il viso, copriforo e portarotolo	<i>Big dimension and capacity professional couch. Completely made in massive wood. 1 lift mattress embossed with foamed polyurethane (15 cm high adjustment). Face-hole with stopper and roll-holder</i>	50	1,30	B	1.250,00
					C	1.200,00

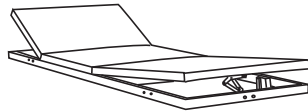

084	Supplemento Wood con 2 snodi	<i>Extra charge for couch with 2 lifts.</i>				100,00
------------	------------------------------	---	--	--	--	---------------

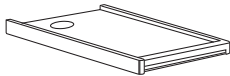

070	Supplemento per ripiano estraibile per sistema Wood vapore.	<i>Extra charge for trolley to carry the steam generator.</i>				200,00
------------	---	---	--	--	--	---------------

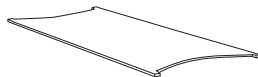

R083	Supplemento per pianale in legno	<i>Extra charge for wood shelf</i>				150,00
-------------	----------------------------------	------------------------------------	--	--	--	---------------

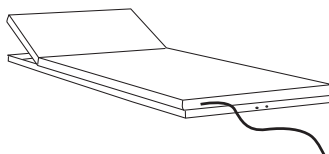

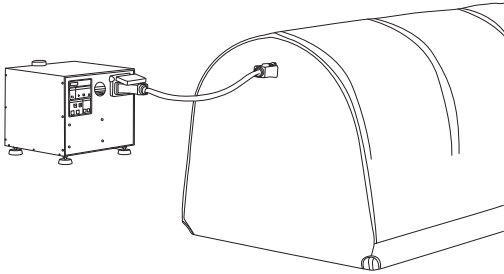

H083	Materasso con fodera in skay imbottito con poliuretano espanso particolarmente confortevole perché dotato di un sistema di riscaldamento che mantiene la temperatura del materasso a circa 37°C.	<i>Mattress with skay cover and polyurethane stuffing. Equipped with an heating plant that keep the mattress temperature to 37°C.</i>				240,00
-------------	--	---	--	--	--	---------------

Wood vapore

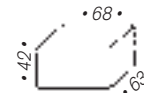
	ART.	Descrizione	Description	Kg.	m ³	Cat.	Euro
	071	Sistema Wood vapore. Generatore di vapore ad alte prestazioni. La sonda all'interno della cappottina consente di mantenere la temperatura preimpostata costante. Il serbatoio dell'acqua è ricaricabile anche durante il trattamento. È predisposta per essere usata con acque termali. Il generatore è dotato di un sistema di auto-diagnostica in grado di visualizzare sul display la tipologia del guasto o del problema riscontrato. In caso di guasto l'erogazione del vapore si blocca automaticamente. Il sistema è composto da 4 archi, realizzati in faggio verniciato resistente all'acqua, richiudibili per un ingombro minimo di 20 cm e una tenda in nylon impermeabile.	Wood vapour system. High performances steam generator. Inside the canvas there is a system that allows to keep the temperature constant. The water tank can be filled also during the treatment. It also can be used with thermal waters. The generator has a self-diagnostic system that can show on its display the kind of problem found. In case of damage the steam delivery is automatically stopped. This system is composed by 4 arcs made of water-proof varnished beech, that can be closed in a minimum space of 20 cm., and of a nylon water-proof cover.	15	0,20		2.380,00
	3172	Sistema Wood vapore senza pompa di ricarica. Il serbatoio consente di effettuare circa 90 minuti di trattamenti prima della ricarica e non è ricaricabile durante i trattamenti	Wood vapour system without refill pump. The tank allows to make more than 90 minutes of treatments before refilling it and it not possible to refill it during the treatment	15	0,20		2.380,00
	A3172	Sistema composto da 4 archi, realizzati in faggio verniciato resistente all'acqua, richiudibili per un ingombro minimo di 20 cm e una tenda in nylon impermeabile.	System composed by 4 arcs made of water-proof varnished beech, that can be closed in a minimum space of 20 cm., and of a nylon water-proof cover.	6	0,20		800,00
	C074	Tenda in nylon impermeabile (ricambio)	Water-proof nylon cover (refill)				145,00
	C3190	Tenda in nylon impermeabile di ricambio per wood abbinato al sistema per aromaterapia.	Water-proof nylon cover for Wood (refill) for aromatherapy.				145,00

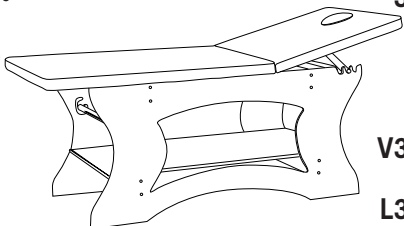
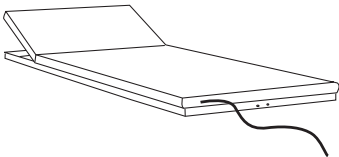

Sunrise

	ART.	Descrizione	Description	Kg.	m ³	Cat.	Euro
L 200 P 75 H 80 	3085	Letto professionale in legno verniciato naturale o wengé, materasso con uno snodo imbottito con poliuretano espanso.	Wood professional couch varnished natural or wengé colours one lift position mattress embossed with foamed polyurethane.	50	1,30	C	880,00
	V3085	Altro colore legno	Other wood colors				180,00
	L3085	Altro colore laccato	Other lacquered colors				290,00
	H3085	Materasso con fodera in skay imbottito con poliuretano espanso particolarmente confortevole perché dotato di un sistema di riscaldamento che mantiene la temperatura del materasso a circa 37°C.	Mattress with skay cover and polyurethane stuffing. Equipped with an heating plant that keep the mattress temperature to 37°C.				240,00
	R3085	Supplemento per pianale in legno	Extra charge for wood shelf				220,00



Wood Comfort

L 73
P 200
H 40

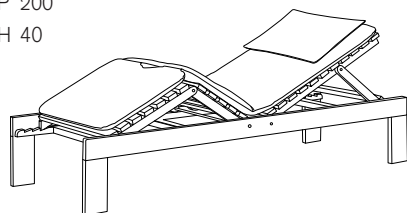

3600 Letto professionale completamente realizzato in legno massello con piano in doghe a 2 snodi

Description

Professional couch. Completely made in massive wood with 2 lift

Kg.

m³

Cat.

Euro

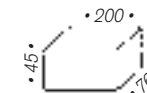

1.200,00

M3600 Materasso in skay

Skay covered mattress

B 300,00

C 250,00

Wood Relax n. 5

L 73
P 200
H 40

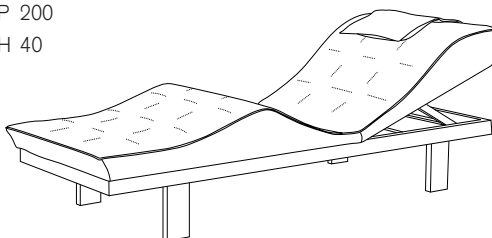

3605 Letto professionale completamente realizzato in legno massello con 1 snodo. Materasso anatomico in skay

Description

Professional couch. Completely made in massive wood with 1 lift. Anatomic skay mattress

Kg.

m³

Cat.

Euro

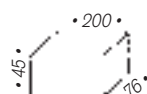

1.300,00

Wood Relax n. 2

L 73
P 200
H 40

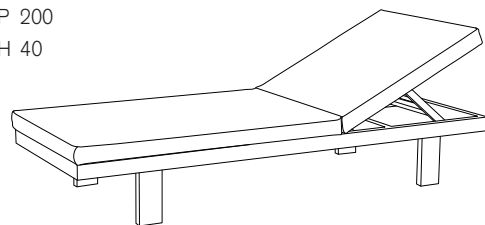

3610 Letto professionale completamente realizzato in legno massello con 1 snodo. Materasso in skay

Description

Professional couch. Completely made in massive wood with 1 lift. Skay mattress

Kg.

m³

Cat.

Euro



1.100,00

Wood Relax

L 60
P 191
H 77

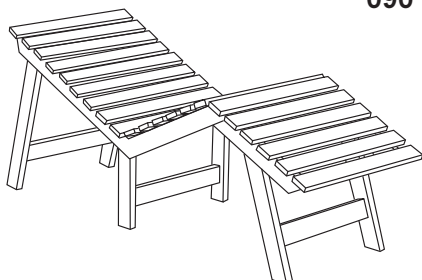

090 Poltrona realizzata in legno massello verniciato nei colori di catalogo, leggera ed ergonomica

Description

Massive wood chair available in all catalogue colours light and ergonomic

Kg.

m³

Cat.

Euro

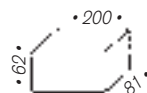

690,00

Armonia

L 120
P 186
H 91

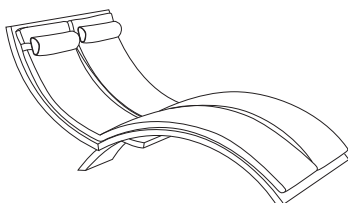

ART.	Descrizione	Description	Kg.	m ³	Cat.	Euro
091	Poltrona d'attesa in legno impiallacciato rovere verniciato con 2 materassi rivestiti in tessuto o in skay nei colori di catalogo	Chair with oak veneer wood with 2 mattress covered with fabric or skay in all catalogues colours	80			2.900,00
H091	2 materassi in skay con rete traspirante	Breathable skay mattress (2)				580,00



Armonia single

L 60
P 186
H 91

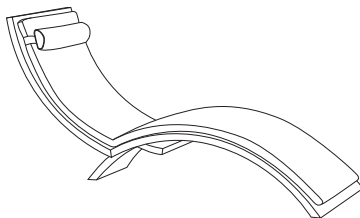

ART.	Descrizione	Description	Kg.	m ³	Cat.	Euro
092	Poltrona d'attesa in legno impiallacciato rovere verniciato con materasso rivestito in tessuto o in skay nei colori di catalogo	Chair with oak veneer wood with mattress covered with fabric or skay in all catalogues colours	40			1.750,00
H092	Materasso in skay con rete traspirante	Breathable skay mattress				290,00



Leonardo

L 62
P 194/214
H 69/86
portata max
130 kg

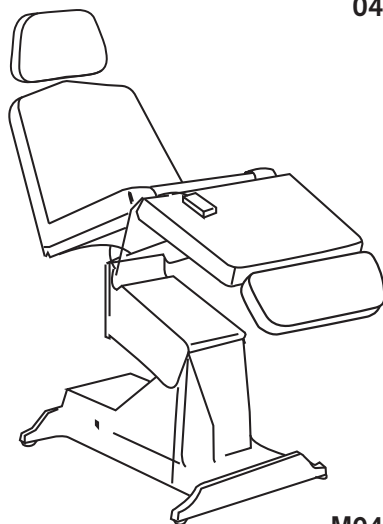

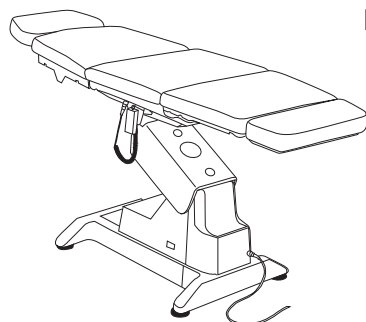
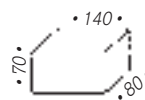

ART.	Descrizione	Description	Kg.	m ³	Cat.	Euro
040	Questo letto è alimentato da una batteria a 12 volt con carica batteria incorporato. Regolato tramite 4 attuatori elettrici a 12 volt e da una centralina elettronica, completamente testati, che soddisfano le specifiche richieste ed esigenze di qualità ed affidabilità, garantendo al cliente di restare tranquillamente adagiato durante le regolazioni senza subire strappi o movimenti bruschi. Tutti gli azionamenti vengono comandati da una pulsantiera semplice e funzionale dotata della funzione di rientro automatico che consente di far tornare il lettino in posizione poltrona da tutte le altre posizioni e 2 memorie per ripristinare le posizioni più usate. È possibile fermare il rientro automatico in qualsiasi momento azionando il pulsante AUT.	This couch is equipped with a 12 volts battery with battery-charger included. It works with 4 electric actuators low voltage 12 V. and an electronic control box. Above components are our own in-house production. These are fully tested to provide quality and reliability as well as smooth couch-adjustment without abrupt motions whatsoever. All functions are controlled by an easy-to-use hand control equipped with automatic return-function allowing the couch the return to armchair position, and 2 memories to reset the most used positions. It is also possible to block the automatic-return function at any time by pressing the button AUT.	78	0,90	B	3.270,00
					C	3.215,00
M040	Motore di ricambio	Electric motor (refill)				145,00

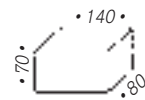

E040	Lettino 040 a comando elettrico senza batteria. Funziona collegato alla presa di corrente ed è alimentato tramite un trasformatore che consente l'arrivo al letto dell'energia elettrica a 12V garantendo assoluta sicurezza.	Couch 040 with electric control, without battery. It works with a transformer connected to the current tap. The current arrives to the couch at 12 volts and for this reason it is completely sure.	75	0,90	B	3.085,00
					C	3.030,00

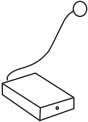
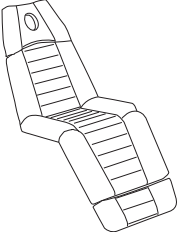
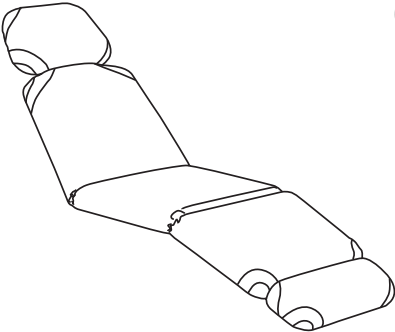

Leonardo

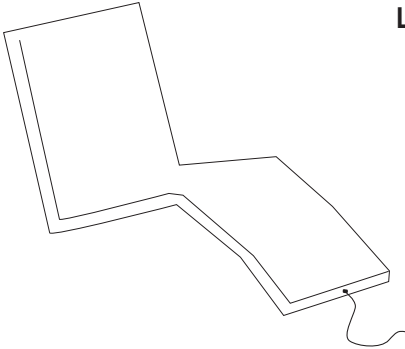
	ART.	Descrizione	Description	Kg.	m ³	Cat.	Euro
	041	Supplemento per comando a pedale (2)	Extra charge for foot-pedal control (2)				130,00
	P041	Supplemento per comando a pedale (6)	Extra charge for foot-pedal control (6)				320,00
	N045	Nuovo materasso anatomico	New anatomic mattress				250,00
	047	Materasso soft	Soft mattress				200,00
	042	Supplemento per braccioli che possono ribaltarsi di 180° garantendo un appoggio stabile e comodo per le braccia del cliente quando si trova con la faccia verso terra	Extra charge for armrests that can fold-back 180° providing a comfortable rest position for arms when lying face down				200,00
	C040	Ciotola per manicure	Manicure basin				40,00
	048	Braccioli 042 soft	Soft armrest 042				200,00
	C040	Ciotola per manicure	Manicure basin				40,00
	3040	Portarotolo	Roll-holder				45,00
	L083	Supplemento per materasso dotato di un sistema di riscaldamento che mantiene la temperatura a circa 37°C.	Extra-charge for mattress with an heating plant that keep the mattress temperature to 37°C.				160,00

Leonardo con pompa

L 62
P 194/214
H 64/84



P040 Lettino con 4 movimenti azionato da pompa oleodinamica con freno e 3 pompe a gas.

Description

Couch with 4 movements produced by 1 oleodynamic pump with brake and 3 gas pumps.

Kg.

60

m³

0,90

Cat.

B

2.130,00

C

2.075,00

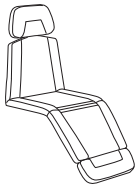
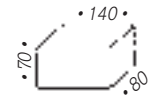

045 Materasso anatomico

Anatomic mattress

160,00

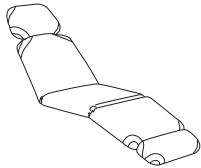

047 Materasso soft

Soft mattress

200,00



042 Supplemento per braccioli che possono ribaltarsi di 180° garantendo un appoggio stabile e comodo per le braccia del cliente quando si trova con la faccia verso terra.

Extra charge for armrests that can fold-back 180° providing a comfortable rest position for arms when lying face down.

200,00

C040 Ciotola per manicure

Manicure basin

40,00



048 Braccioli 042 soft

Soft armrests 042

200,00

C040 Ciotola per manicure

Manicure basin

40,00



3040 Portarotolo

Roll-holder

45,00

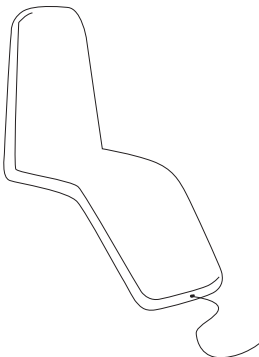

L083 Supplemento per materasso dotato di un sistema di riscaldamento che mantiene la temperatura a circa 37°C.

Extra-charge for mattress with an heating plant that keep the mattress temperature to 37°C.

160,00

Galileo

L 80
P 90
H 64/84



ART.	Descrizione	Description	Kg.	m ³	Cat.	Euro
046	Poltrona da podologia a funzionamento meccanico con telaio in acciaio zincato azionata con pompa oleodinamica con freno. Movimenti tramite 3 molle a gas. Sedile, schienale e poggiatesta in legno multistrato (11 mm) imbottito con poliuretano espanso (40 kg/m ³)	Podology chair in zinc-plated steel with mechanical movement and oleodynamic pump with brake. Movements are made by 3 gas pumps. Multilayered wood seat, back and leg-rest (thickness 11 mm) stuffed with foamed polyurethane (40 kg/m ³)	51	0,90	B	2.530,00
C040	Ciotola per manicure	Manicure basin			C	2.475,00
						40,00

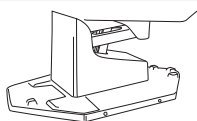
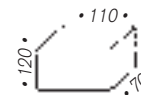

E046	Poltrona 046 con alzata elettrica comandata a pedale.	Podology chair 046 with electric lift and foot-pedal control.	70	0,90	B	2.850,00
					C	2.795,00

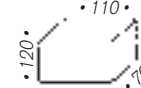

3040	Portarotolo	Roll-holder				45,00
-------------	-------------	-------------	--	--	--	--------------

Tiepolo

L 65
P 70
H 108

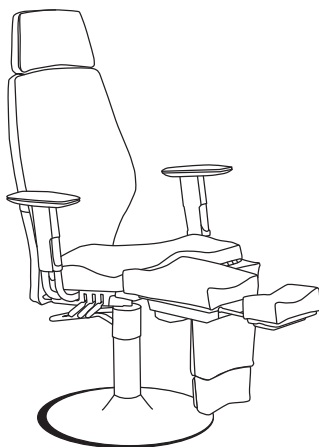

ART.	Descrizione	Description	Kg.	m ³	Cat.	Euro
3030	Poltrona da podologia con movimento dello schienale meccanico e poggiatesta a regolazione indipendente con molla a gas. Sedile, schienale e poggiatesta a regolazione indipendente. Sedile, schienale e poggiatesta in legno multistrato (spess. 11 mm) imbottito con poliuretano espanso (40 kg/m ³). Braccioli estraibili con struttura portante in ferro ricoperto con poliuretano espanso integrale.	Podology chair with mechanical back movement and independent adjustment leg-rest with gas cylinder. Independent adjustment of back, seat and leg-rest. Multilayered wood seat, back and leg-rest (thickness 11 mm) stuffed with foamed polyurethane (40 kg/m ³). Adjustable armrests with iron structure covered with integral foamed polyurethane.			B	1.490,00
					C	1.440,00



D110	Supplemento per base a disco inox	Extra charge for stainless steel disc base				40,00
-------------	-----------------------------------	--	--	--	--	--------------

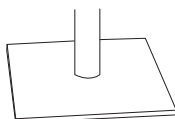

D112	Supplemento per base quadra inox	Extra charge for stainless steel square base				50,00
-------------	----------------------------------	--	--	--	--	--------------

Megane

L 63
P 68
H 103/123

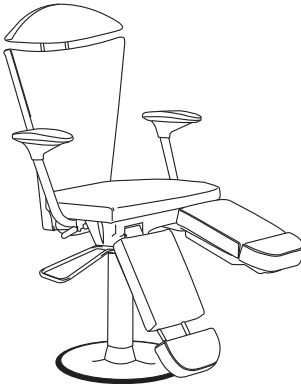

3024 Poltrona da podologia con movimento dello schienale meccanico con molla a gas e poggiatesta a regolazione indipendente. Sedile, schienale e poggiatesta a regolazione indipendente. Sedile, schienale e poggiatesta in legno multistrati (spess. 11 mm) imbottito con poliuretano espanso (40 kg/m³). Braccioli con struttura portante in ferro ricoperto con poliuretano espanso integrale.

Podology chair with mechanical back movement with gas cylinder and independent adjustment leg-rest. Independent adjustment of back, seat and leg-rest. Multilayered wood seat, back and leg-rest (thickness 11 mm) stuffed with foamed polyurethane (40 kg/m³). Armrests with iron structure covered with integral foamed polyurethane.

Kg. m³ Cat. Euro

36 0,60 **B 1.150,00**

C 1.100,00

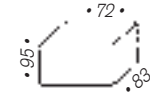

D110 Supplemento per base a disco inox

Extra charge for stainless steel disc base

40,00

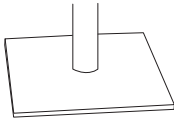

D112 Supplemento per base quadra inox

Extra charge for stainless steel square base

50,00

Tiepolo single

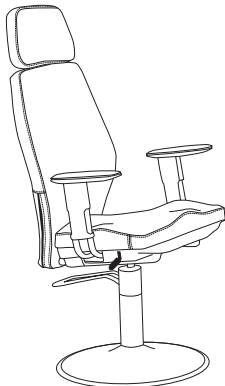

3031 Poltrona con movimento dello schienale meccanico. Sedile, schienale a regolazione indipendente. Sedile, schienale in legno multistrati (spess. 11 mm) imbottito con poliuretano espanso (40 kg/m³). Braccioli estraibili con struttura portante in ferro ricoperto con poliuretano espanso integrale.

Chair with mechanical back movement. Independent adjustment of back and seat. Multilayered wood seat and back (thickness 11 mm) stuffed with foamed polyurethane (40 kg/m³). Adjustable armrests with iron structure covered with integral foamed polyurethane.

Kg. m³ Cat. Euro

B 1.120,00

C 1.075,00



D110 Supplemento per base a disco inox

Extra charge for stainless steel disc base

40,00

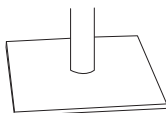



D112 Supplemento per base quadra inox

Extra charge for stainless steel square base

50,00

Tiepolo System

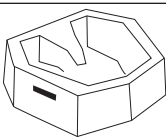
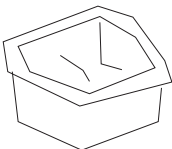
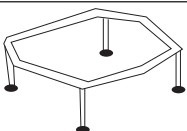
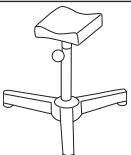
	ART.	Descrizione	Description	Kg.	m ³	Cat.	Euro
	V1199	Vasca pedicure integrata con poggia-gamba.	<i>Abs pedicure basin with leg-rest.</i>				330,00
	L1211	Lampada con lente.	<i>Lamp with magnifying glass.</i>				80,00
	1199	Vaschetta pedicure in ABS	<i>Abs pedicure basin.</i>				65,00
	R1199	Ricambi igienici monouso per vaschetta pedicure (50 pz).	<i>Sanitary, throwaway refill for pedicure basin (50 pcs).</i>				75,00
	S1199	Telaio per vaschetta 1199 in ferro zincato.	<i>Zinc plated iron structure for pedicure basin 1199.</i>				60,00
	1204	Poggia-gamba	<i>Leg-rest</i>				90,00

Genius

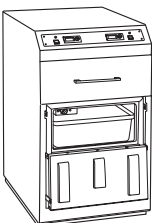
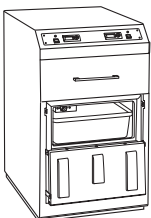
	ART.	Descrizione	Description	Kg.	m ³	Cat.	Euro
L 50 P 64 H 87 	3135	Carrello dotato di 1 piano riscaldante fino a 120°C, di 1 cassetto termico in acciaio (65°C) e di 1 cassetto refrigerato (-1°C) realizzato in legno impiallacciato rovere verniciato nei colori di catalogo	<i>Trolley with a heating top (up to 120°C), a thermal steel drawer (up to 65°C) and a cooling drawer (-1°C) made of oak veneer wood available in all catalogues colours</i>	45			3.900,00
L 50 P 64 H 87 	3136	Carrello dotato di 1 piano riscaldante fino a 120°C, di 1 cassetto termico in acciaio (65°C) e di 1 cassetto refrigerato (-1°C) realizzato in nobilitato nei colori di catalogo	<i>Trolley with a heating top (up to 120°C), a thermal steel drawer (up to 65°C) and a cooling drawer (-1°C) made of laminated wood available in all catalogues colours</i>	50			3.400,00

Aquaria carrello

L 50
P 50
H 88



3440 Carrello in legno massello verniciato nei colori di catalogo completo di 2 piani estraibili e di 1 vassoio asportabile

Massive wood trolley varnished in the colours available in the catalogue complete with 2 pull out shelves and 1 removable container

Kg. 20 m³ 0,27
• 55 •
• 92 •
• 55 •

1.100,00

Carrelli

L 85
P 40
H 93



072 Carrello Wood vapore con 2 ripiani in cristallo 74x38 cm.

Wood vapour trolley with 2 cristal shelf 74x38 cm.

Kg. 17 m³ 0,45
• 100 •
• 100 •
• 45 •

440,00

L 85
P 40
H 93



094 Carrello di servizio con 3 ripiani in cristallo cm 74x38.

3 cristal shelf trolley in massive wood cm 74x38.

Kg. 18 m³ 0,45
• 100 •
• 100 •
• 45 •

440,00

L 53
P 40
H 93

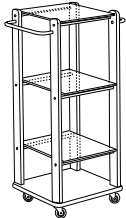

093 Carrello di servizio con 3 ripiani in cristallo cm 40x38

3 cristal shelf trolley in massive wood cm 40x38

Kg. 14 m³ 0,25
• 55 •
• 100 •
• 45 •

390,00

B1209 Carrello per manicure bianco

White nail station

18

195,00

1211 Carrello portastrumenti in metallo verniciato bianco

White varnished metal trolley

18

200,00

E1211 Set elettrico

Electric set

3

120,00

L1211 Lampada

Lamp

80,00

Carrelli

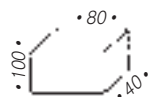
	ART.	Descrizione	Description	Kg.	m ³	Cat.	Euro
L 77 P 38 H 93	1210	Carrello di servizio in metallo verniciato bianco cm 77x38	White varnished metal trolley cm 77x38	20	0,32		200,00
							

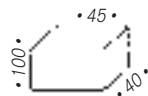
L 44 P 38 H 93	M1210	Carrello di servizio in metallo verniciato bianco cm 44x38	White varnished metal trolley cm 44x38	16	0,20		185,00
							

Aura carrello

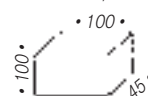
	ART.	Descrizione	Description	Kg.	m ³	Cat.	Euro
L 90 P 40 H 95	3130	Carrello coordinato assemblato con gli stessi legni e negli stessi colori del letto nello stesso colore del carrello.	Trolley with wood wheels, coordinated with aura couch, made of the same wood and colour.	25	0,45		980,00
							

Aura carrello thermo

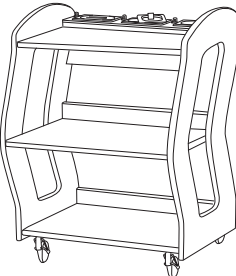
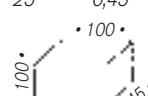
	ART.	Descrizione	Description	Kg.	m ³	Cat.	Euro
L 90 P 40 H 95	3132	Carrello coordinato assemblato con gli stessi legni e negli stessi colori del letto. Dotato di sistema di riscaldamento con 3 vassoi con termostato indipendente.	Trolley coordinated with aura couch, made of the same wood and colours. Warming system with tree basins and independent regulation.	25	0,45		1.550,00
							

Pulsar

	ART.	Descrizione	Description	Kg.	m ³	Cat.	Euro
	3030	Sistema a fibre ottiche da mm 1 per ottenere un cielo stellato del colore desiderato (260 fibre).	1 mm fiber optics device to produce a starry sky of the whised colour (260 fibers).				800,00
	3035	Sistema a fibre ottiche da mm 1,5 per ottenere un cielo stellato del colore desiderato (190 fibre).	1,5 mm fiber optics device to produce a starry sky of the whised colour (190 fibers).				980,00
	3040	Sistema a fibre ottiche da mm 2 per ottenere un cielo stellato del colore desiderato (90 fibre).	2 mm fiber optics device to produce a starry sky of the whised colour (90 fibers).				980,00
L 90 P 200	3045	Cielo stellato con struttura in nobilitato nei colori di catalogo (circa 1,8 m ²).	Starry sky with laminated structure in catalogue colours (about 1,8 m ²).				1.170,00
L 90 P 200	3046	Cielo stellato con struttura in nobilitato nei colori di catalogo rettangolare Nota bene: La quantità di fibre per ogni fascio e la loro lunghezza nonché la dimensione e la forma del cielo stellato sono modificabili. Vi preghiamo di segnalarci le vostre esigenze e di chiedere preventivamente il prezzo.	Starry sky with laminated structure in catalogue colours rectangular Note: The amount of fibers for each beam and their length, the size and shape of the starry sky may vary as required. Please let us know your needs to have an offer.				980,00

Goccia

	ART.	Descrizione	Description	Kg.	m ³	Cat.	Euro
L 37 P 24 H 25	3192	Diffusore di essenze per aromaterapia in legno massello verniciato nei colori di catalogo adatto per la diffusione di aromi nell'ambiente completo di una bottiglia in vetro.	Essential oils diffuser for aromatherapy, suitable to spread aromas in the room. Made of wood, is available in catalogue's colours, provided with a glass bottle.	5	0,05		1.320,00
	3190	Diffusore di essenze per aromaterapia solo unito con sistema Wood vapore e Aquaria vapore completo di una bottiglia in vetro.	Essential oils diffuser for swedana aromatherapy, to be used only with Wood and Aquaria steam system. Provided with a glass bottle.	4	0,05		1.070,00
L 33 P 19 H 24	3191	Diffusore di essenze per aromaterapia solo unito con sistema Aura vapore completo di una bottiglia in vetro.	Essential oils diffuser for swedana aromatherapy, to be used only with Aura steam system. Provided with a glass bottle.	4	0,05		1.130,00
	3194	Set di 4 bottiglie con espositore in legno verniciato nei colori di catalogo.	4 bottles set with its wood display available in catalogue's colours.				240,00
	3193	Bottiglia in vetro di ricambio	Spare glass bottle				40,00

Terra

	ART.	Descrizione	Description	Kg.	m ³	Cat.	Euro
L 36 P 34 H 24	3200	Sistema per riscaldare a temperatura costante pietre, alghe ed altri trattamenti.	Device to warm stones, algae and other Terra treatments to the fixed temperature.	7	0,20		670,00
	3210	Vaschetta grande	Large basin				85,00
	3230	Vaschetta piccola	Small basin				125,00

Aloe

L 100
P 45
H 83

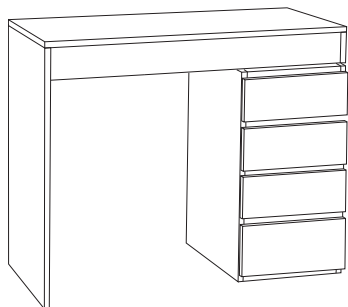

ART.	Descrizione	Description	Kg.	m ³	Cat.	Euro
4940	Tavolo per manicure con struttura in legno impiallacciato rovere verniciato nei colori di catalogo.	Work-table for manicure with structure of veneered oak wood painted in catalogue's colours.	35	0,90		1.360,00
4941	Tavolo per manicure con struttura in nobilitato nei colori di catalogo	Work-table for manicure with laminated structure in catalogue's colours.	60	0,90		920,00
4942	Tavolo per manicure con struttura in nobilitato laccato nei colori di catalogo.	Work-table for manicure with laminated structure varnished in catalogue's colours.	45	0,90		920,00

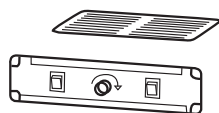
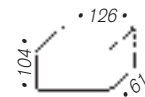

4943	Sistema di aspirazione e ventilazione per tavolo manicure.	Aspiration system for work-table for manicure.	45	0,90		300,00
-------------	--	--	----	------	--	---------------

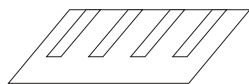

4944	Sistema di aspirazione e ventilazione con 4 lampade a raggi ultravioletti per la ricostruzione delle unghie.	Aspiration system with 4 an ultraviolet ray lamp for nail reconstruction.	45	0,90		640,00
-------------	--	---	----	------	--	---------------



4945	Cuscino in skay	Cushion with skay cover				42,00
-------------	-----------------	-------------------------	--	--	--	--------------

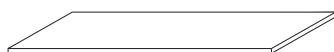

4946	Supplemento ripiano in vetro	Extra charge for cristal top				93,00
-------------	------------------------------	------------------------------	--	--	--	--------------

Timo

L 50
P 100
H 78

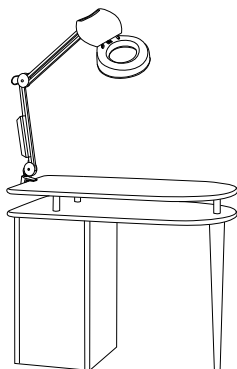

ART.	Descrizione	Description	Kg.	m ³	Cat.	Euro
3950	Tavolo per manicure con struttura in nobilitato nei colori di catalogo completo di lampada lente e aspiratore	Work-table for manicure with laminated structure in catalogue's colours aspiration system and lamp are included	42	0,50		880,00
A3950	Sistema di aspirazione	Aspiration system				85,00

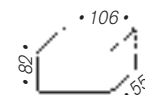

Megane viso

L 63
P 94
H 103/123



3034 Poltrona da trucco con movimento dello schienale meccanico con molla a gas e poggiatesta a regolazione indipendente. Sedile, schienale in legno multistrati (spessore 11 mm) imbottito con poliuretano espanso (40 kg/m³). Braccioli con struttura portante in ferro ricoperto con poliuretano espanso integrale.

Make up chair with mechanical back-rest movement with gas cylinder and independent adjustment of head-rest. Multilayered wood seat and back (thickness 11 mm) stuffed with foamed polyurethane (40 kg/m³) armrest with iron structure covered with integral foamed polyurethane.

Kg. 33 m³ 0,65

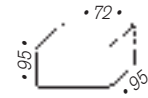

B 1.060,00
C 1.020,00



D110 Supplemento per base a disco inox

Extra charge for stainless steel disc base

40,00

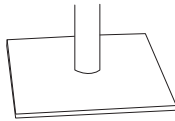

D112 Supplemento per base quadra inox

Extra charge for stainless steel square base

50,00

Tecno viso

L 100
H 200

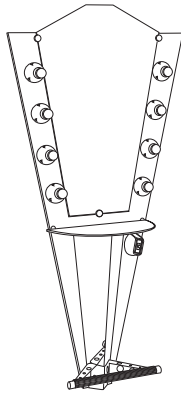

836 Posto di lavoro in metallo verniciato nei colori di catalogo e piano in cristallo verniciato nei colori di catalogo con impianto elettrico a 8 punti luce

Styling unit made in varnished iron (available in catalogue colours) varnished cristal top (available in catalogue colours) and 8 light points

Kg. 48 m³ 0,25

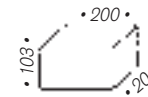

1.170,00

L836 Solo impianto 8 punti luce

8 light points

300,00

Accessori



M3100 Materasso per Aura

Latex mattress

B 300,00

C 250,00



C3100 Cuscino per Aura

Aura cushion

42,00

C3450 Cuscino per Creta

Creta cushion

42,00

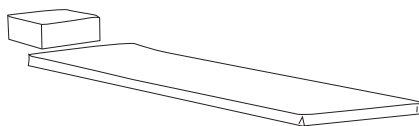

3110 Materasso a cellula chiusa e cuscino con fodera in spugna per Aura.

Latex mattress and cushion with cotton cover.

110,00

R3110 Fodera in spugna di cotone per cuscino 3110 (ricambio).

Cotton cover for cushion 3110 (refill).









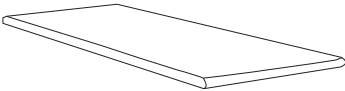
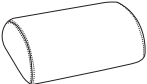
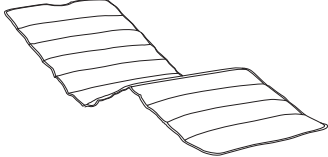

20,00

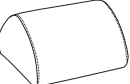
3111 Coprimaterasso per materasso 3110 in TNT (10 pz).

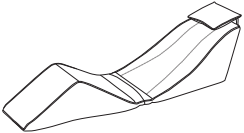





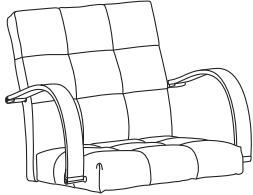

Mattress cover for 3110 made of TNT fabric (10 pcs).

62,00



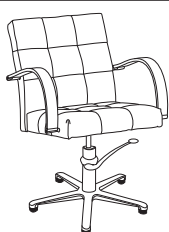



Accessori

	ART.	Descrizione	Description	Kg.	m ³	Cat.	Euro
	3082	Poggiatesta anatomico per Shirodhara	Head-rest for Shirodhara				48,00
	M074	Coprimaterasso in spugna di cotone	Cotton sponge mattress cover				68,00
	V074	Cuscino con fodera in spugna di cotone	Cushion covered with cotton sponge				48,00
	R074	Fodera in spugna di cotone per cuscino V074 (ricambio)	Cotton sponge cushion cover V074 (refill)				20,00
	C079	Cuscino con fodera in cotone	Cushion with cotton cover				48,00
	M090	Copridoghe con fodera in cotone per Wood relax	Cotton covering for Wood relax				155,00
	082	Poggiatesta	Head-rest				42,00
	T082	Cuscino per collo	Neck-rest				27,00
	G082	Cuscino per ginocchio	Knee-rest				48,00
	L082	Cuscino per supporto lombare	Cushion for lumbar support				42,00
	R082	Cuscino relax	Relax cushion			B	375,00
						C	310,00
	3083	Cuscino lungo cm 50	Long-rest cm 50				42,00
	3084	Cuscino quadro	Square-rest				42,00
	3085	Cuscino per seno	Breast-rest				48,00
	3086	Cuscino per ginocchia	Knee-rest				48,00
	3087	Cuscino per gambe	Legs-rest				48,00

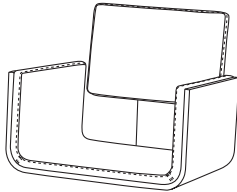
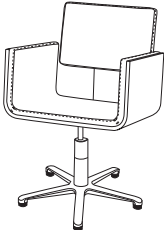



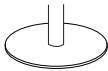

Corinne

	ART.	Descrizione	Description	Kg.	m ³	Cat.	Euro
L 60 P 62 H 53		210 Poltrona da lavoro con struttura in legno multistrati (spess. 11 mm) imbottita con poliuretano espanso. Braccioli in Corian®.	Styling chair with multilayered wood inside (thickness 11 mm) stuffed with foamed polyurethane (40 kg/m ³). Corian® armrests.	9,5	0,20	B	560,00
		C210 Cuffia antimacchia	Save-spot protection			C	535,00
							25,00
L 60 P 62 H 93		211 Poltrona 210 con base in alluminio a 5 raggi e colonna girevole cromata	Chair 210 with aluminium 5 radius base and chromium-plated swivel column	13	0,20	B	670,00
						C	640,00
L 60 P 62 H 92		212 Poltrona 210 con base in alluminio a 5 raggi e pompa oleodinamica cromati	Chair 210 with aluminium 5 radius base and chromium-plated oleodynamic pump	17,9	0,20	B	815,00
						C	785,00
L 60 P 62 H 91		213 Poltrona 210 con base in alluminio a 5 raggi e pompa oleodinamica con freno cromati	Chair 210 with aluminium 5 radius base and chromium-plated oleodynamic pump with brake	20,4	0,20	B	885,00
						C	855,00
L 60 P 62 H 91		216 Poltrona 210 con base in alluminio a 5 raggi e pompa a gas cromata	Chair 210 with aluminium 5 radius base and chromium-plated gas pump	15,5	0,20	B	690,00
						C	660,00
		4109 Supplemento per base a disco cromato	Extra charge for chromium-plated disk base				30,00
		4110 Supplemento per base a disco inox	Extra charge for stainless steel disk base				70,00
		4112 Supplemento per base inox quadra	Extra charge for stainless steel square base				80,00

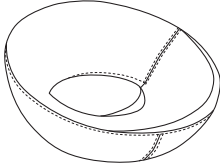
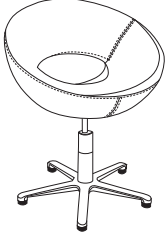

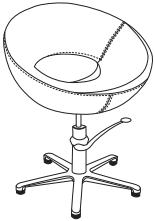

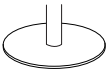

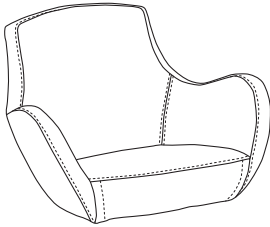

Melissa

	ART.	Descrizione	Description	Kg.	m ³	Cat.	Euro
L 62 P 50 H 50		4100 Poltrona da lavoro con struttura in legno imbottita con poliuretano espanso (40 kg/m ³). Braccioli e schienale in legno multistrati verniciati nei colori di catalogo. Supporto dello schienale in alluminio pressofuso.	<i>Styling chair with multilayered wood structure and foamed polyurethane stuffing (40 kg/m³). Armrests and backrest varnished in catalogue's colours. Backrest with aluminum support.</i>	13	0,20	A	600,00
						B	590,00
						C	570,00
	C4100	Cuffia antimacchia	<i>Save-spot protection</i>				25,00
L 62 P 50 H 95		4101 Poltrona 4100 con base in alluminio a 5 raggi e colonna girevole cromata	<i>Chair 4100 with aluminium 5 radius base and chromium-plated swivel column</i>	16	0,20	A	710,00
						B	700,00
						C	680,00
L 62 P 50 H 95		4102 Poltrona 4100 con base in alluminio a 5 raggi e pompa oleodinamica cromati	<i>Chair 4100 with aluminium 5 radius base and chromium-plated oleodynamic pump</i>	21	0,20	A	855,00
						B	845,00
						C	825,00
L 62 P 50 H 95		4103 Poltrona 4100 con base in alluminio a 5 raggi e pompa oleodinamica con freno cromati	<i>Chair 4100 with aluminium 5 radius base and chromium-plated oleodynamic pump with brake</i>	23	0,20	A	925,00
						B	915,00
						C	895,00
L 62 P 50 H 95		4106 Poltrona 4100 con base in alluminio a 5 raggi e pompa a gas cromata	<i>Chair 4100 with aluminium 5 radius base and chromium-plated gas pump</i>	19	0,20	A	730,00
						B	720,00
						C	700,00
		4109 Supplemento per base a disco cromato	<i>Extra charge for chromium-plated disk base</i>				30,00
		4110 Supplemento per base a disco inox	<i>Extra charge for stainless steel disc base</i>				70,00
		4112 Supplemento per base inox quadra	<i>Extra charge for stainless steel square base</i>				80,00





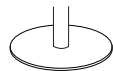



Luna

		ART.	Descrizione	Description	Kg.	m ³	Cat.	Euro
L 63 P 58 H 43		100	Poltrona da lavoro con struttura in acciaio, interamente stampata in poliuretano schiumato a freddo.	Styling chair with steel frame and foamed polyurethane structure.	9	0,20	B	455,00
		C100	Cuffia antimacchia	Save-spot protection			C	415,00
								40,00
L 63 P 58 H 83		101	Poltrona 100 con base in alluminio a 5 raggi e colonna girevole cromata	Chair 100 with aluminium 5 radius base and chromium-plated swivel column	12,5	0,20	B	565,00
							C	525,00
L 63 P 58 H 82		102	Poltrona 100 con base in alluminio a 5 raggi e pompa oleodinamica cromati	Chair 100 with aluminium 5 radius base and chromium-plated oleodynamic pump	17,5	0,20	B	710,00
							C	670,00
L 63 P 58 H 81		103	Poltrona 100 con base in alluminio a 5 raggi e pompa oleodinamica con freno cromati	Chair 100 with aluminium 5 radius base and chromium-plated oleodynamic pump with brake	19,5	0,20	B	780,00
							C	740,00
L 63 P 58 H 81		106	Poltrona 100 con base in alluminio a 5 raggi e pompa a gas cromata	Chair 100 with aluminium 5 radius base and chromium-plated gas pump	15	0,20	B	585,00
							C	545,00
		4109	Supplemento per base a disco cromato	Extra charge for chromium-plated disk base				30,00
		4110	Supplemento per base a disco inox	Extra charge for stainless steel disc base				70,00
		4112	Supplemento per base inox quadra	Extra charge for stainless steel square base				80,00



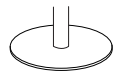

Venere

	ART.	Descrizione	Description	Kg.	m ³	Cat.	Euro
L 66 P 53 H 55		130 Poltrona da lavoro con struttura in acciaio, interamente stampata in poliuretano schiumato a freddo.	<i>Styling chair with steel frame and foamed polyurethane structure.</i>	15	0,20	B	530,00
		C130 Cuffia antimacchia	<i>Save-spot protection</i>			C	490,00
							25,00
L 64 P 60 H 86		131 Poltrona 130 con base in alluminio a 5 raggi e colonna girevole cromata	<i>Chair 130 with aluminium 5 radius base and chromium-plated swivel column</i>	18,5	0,20	B	640,00
						C	600,00
L 64 P 60 H 85		132 Poltrona 130 con base in alluminio a 5 raggi e pompa oleodinamica cromati	<i>Chair 130 with aluminium 5 radius base and chromium-plated oleodynamic pump</i>	23,5	0,20	B	785,00
						C	745,00
L 64 P 60 H 84		133 Poltrona 130 con base in alluminio a 5 raggi e pompa oleodinamica con freno cromati	<i>Chair 130 with aluminium 5 radius base and chromium-plated oleodynamic pump with brake</i>	25,5	0,20	B	855,00
						C	815,00
L 64 P 60 H 84		136 Poltrona 130 con base in alluminio a 5 raggi e pompa a gas cromata	<i>Chair 130 with aluminium 5 radius base and chromium-plated gas pump</i>	21	0,20	B	660,00
						C	620,00
		4109 Supplemento per base a disco cromato	<i>Extra charge for chromium-plated disk base</i>				30,00
		4110 Supplemento per base a disco inox	<i>Extra charge for stainless steel disk base</i>				70,00
		4112 Supplemento per base inox quadra	<i>Extra charge for stainless steel square base</i>				80,00



Diva

	ART.	Descrizione	Description	Kg.	m ³	Cat.	Euro
L 66 P 53 H 55		380 Poltrona da lavoro con struttura in tubo di precisione (UNI7947-KMFE320) conificato e cromato con sedile e schienale in legno multistrati (spess. 11 mm), imbottiti con poliuretano espanso (40 kg/m ³). Braccioli in legno verniciato nei colori di catalogo.	<i>Styling chair with chromium-plated precision tube frame (UNI7947-KMFE320). Back and seat in multilayered wood (thickness 11 mm) stuffed with foamed polyurethane (40 kg/m³). Varnished wood armrests available catalogue colours.</i>	7,2	0,20	B	465,00
						C	435,00
		C380 Cuffia antimacchia	<i>Save-spot protection</i>				25,00
L 66 P 53 H 90		381 Poltrona 380 con base in alluminio a 5 raggi e colonna girevole cromata	<i>Chair 380 with aluminium 5 radius base and chromium-plated swivel column</i>	10,7	0,20	B	575,00
						C	545,00
L 66 P 53 H 89		382 Poltrona 380 con base in alluminio a 5 raggi e pompa oleodinamica cromati	<i>Chair 380 with aluminium 5 radius base and chromium-plated oleodynamic pump</i>	15,6	0,20	B	720,00
						C	690,00
L 66 P 53 H 88		383 Poltrona 380 con base in alluminio a 5 raggi e pompa oleodinamica con freno cromati	<i>Chair 380 with aluminium 5 radius base and chromium-plated oleodynamic pump with brake</i>	18,1	0,20	B	790,00
						C	760,00
L 66 P 53 H 88		386 Poltrona 380 con base in alluminio a 5 raggi e pompa a gas cromata	<i>Chair 380 with aluminium 5 radius base and chromium-plated gas pump</i>	13,1	0,20	B	595,00
						C	565,00
		B105 Supplemento per schienale basculante	<i>Extra charge for back moving system</i>				50,00
		325 Poggiapiedi	<i>Feet-rest</i>				60,00
		4109 Supplemento per base a disco cromato	<i>Extra charge for chromium-plated disk base</i>				30,00
		4110 Supplemento per base a disco inox	<i>Extra charge for stainless steel disc base</i>				70,00
		4112 Supplemento per base inox quadra	<i>Extra charge for stainless steel square base</i>				80,00

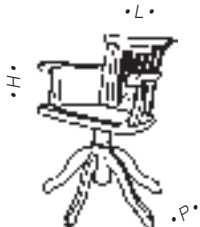

Sharon

	ART.	Descrizione	Description	Kg.	m ³	Cat.	Euro
L 57 P 54 H 50	110	Poltrona da lavoro con struttura in tubo di precisione (UNI7947-KMFE320) cromato con sedile e schienale in legno multistrati (spess. 11 mm), imbottito con poliuretano espanso (40 kg/m ³). Braccioli con inserto in ferro ricoperto con poliuretano espanso integrale.	Styling chair with chromium-plated precision tube frame (UNI7947-KMFE320). Seat and back in multilayered wood (thickness 11 mm) stuffed with foamed polyurethane (40 kg/m ³). Armrests with inside iron structure covered with integral foamed polyurethane.	7,2	0,20	B	365,00
						C	335,00
	C380	Cuffia antimacchia	Save-spot protection				25,00
L 57 P 54 H 90	111	Poltrona 110 con base in alluminio a 5 raggi e colonna girevole cromata	Chair 110 with aluminium 5 radius base and chromium-plated swivel column	10,7	0,20	B	475,00
						C	445,00
L 57 P 54 H 89	112	Poltrona 110 con base in alluminio a 5 raggi e pompa oleodinamica cromati	Chair 110 with aluminium 5 radius base and chromium-plated oleodynamic pump	15,6	0,20	B	620,00
						C	590,00
L 57 P 54 H 88	113	Poltrona 110 con base in alluminio a 5 raggi e pompa oleodinamica con freno cromati	Chair 110 with aluminium 5 radius base and chromium-plated oleodynamic pump with brake	18,1	0,20	B	690,00
						C	660,00
L 57 P 54 H 88	116	Poltrona 110 con base in alluminio a 5 raggi e pompa a gas cromata	Chair 110 with aluminium 5 radius base and chromium-plated gas pump	13,1	0,20	B	495,00
						C	465,00
	B105	Supplemento per schienale basculante	Extra charge for back moving system				50,00
	325	Poggiapiedi	Feet-rest				60,00
	4109	Supplemento per base a disco cromato	Extra charge for chromium-plated disk base				30,00
	4110	Supplemento per base a disco inox	Extra charge for stainless steel disk base				70,00
	4112	Supplemento per base inox quadra	Extra charge for stainless steel square base				80,00
	119	Supplemento per braccioli in legno verniciato nei colori di catalogo	Extra charge for varnished wood armrests in catalogue colours				30,00

Epoca

		ART.	Descrizione	Description	Kg.	m ³	Cat.	Euro
L 58 P 42 H 87		050	Poltrona da lavoro in faggio massiccio verniciato con sedile in legno multistrati (spess. 11 mm), imbottito con poliuretano espanso (70 kg/m ³). Piede in faggio massiccio verniciato con raccordo in ferro verniciato nero e movimento a vite	<i>Styling chair in varnished massive beech. Seat in multilayered wood (thickness 11 mm) stuffed with foamed polyurethane (70 kg/m³). Massive varnished beech base with black varnished bush and self elevation column</i>	15	0,20		800,00
L 58 P 42 H 87		051	Poltrona 050 con pompa oleodinamica con freno anziché movimento a vite	<i>Chair 050 with oleodynamic pump with brake instead of self elevation column</i>	18	0,20		1.010,00

Max

		ART.	Descrizione	Description	Kg.	m ³	Cat.	Euro
L 60 P 90 H 98		013	Poltrona da lavoro con struttura in lamiera di ferro decappata e verniciata. Movimento dello schienale e della pedana meccanico con molla a gas (stabilus). Sedile e schienale in legno multistrato (spess. 20 mm), imbottito con poliuretano espanso (40 kg/m ³). Bracciolo e pedana con struttura portante in ferro ricoperto con poliuretano espanso integrale, finiture in legno massiccio verniciato per pedana e braccioli. Base e pompa oleodinamica con freno cromate	<i>Styling chair with varnished iron frame. Back footboard mechanical movements with gas cylinder (stabilus). Seat and back in multilayered wood (thickness 20 mm) stuffed with foamed polyurethane (40 kg/m³). Armrests and footboard with inside iron frame covered with integral foamed polyurethane and massive wood particulars. Chromium-plated base and chromium-plated oleodynamic pump with brake</i>	62	0,60		B 1.570,00 C 1.520,00
		015	Poltrona 013 con pedana rivestita in skay	<i>Chair 013 with footboard covered with skay</i>				B 1.550,00 C 1.500,00
		B018	Poltrona 013 con basamento elettrico alimentato con batteria	<i>Chair 013 with electric base working with a battery</i>				B 2.160,00 C 2.110,00
		B019	Poltrona 015 con basamento elettrico alimentato con batteria	<i>Chair 015 with electric base working with a battery</i>				B 2.140,00 C 2.090,00
		E018	Poltrona 013 con basamento elettrico alimentato dalla rete	<i>Chair 013 with electric base working connected to the current tap</i>				B 1.990,00 C 1.940,00
		E019	Poltrona 015 con basamento elettrico alimentato dalla rete	<i>Chair 015 with electric base working connected to the current tap</i>				B 1.970,00 C 1.920,00
		E017	Supplemento per braccioli in legno massiccio verniciato	<i>Extra charge for varnished massive wood armrests</i>				30,00

Andrea

L 63
P 102
H 100



032 Poltrona da lavoro con struttura in lamiera di ferro decappata e verniciata. Movimento dello schienale meccanico con molla a gas. Sedile e schienale in legno multistrato (spess. 20 mm) imbottito con poliuretano espanso (40 kg/m³). Bracciolo e pedana con struttura portante in ferro. Pedana rivestita con poliuretano espanso integrale. Braccioli autoregolanti in legno massiccio verniciato nei colori di catalogo. Base e pompa oleodinamica con freno cromate.

Description

Styling chair with varnished iron frame. Back mechanical movements with gas cylinder. Seat and back in multilayered wood (thickness 20 mm) stuffed with foamed polyurethane (40 kg/m³). Armrests and footboard with inside iron frame covered with integral foamed polyurethane. Self-regulating armrests in massive wood, varnished in catalogue colours. Black base and black oleodynamic pump.

Kg.

40

m³

0,60

Cat.

B 1.400,00

C 1.360,00

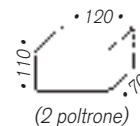

033 Poltrona 032 con basamento elettrico alimentato con batteria

Chair 032 with electric base working with a battery

B 2.000,00

C 1.940,00

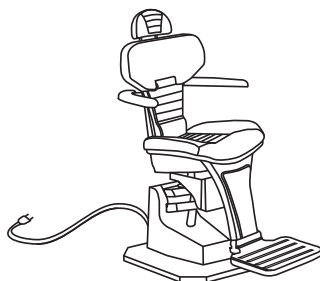

034 Poltrona 032 con basamento elettrico alimentato dalla rete

Chair 032 with electric base working connected to the current-tap

B 1.810,00

C 1.770,00

Basi per poltrone

ART. Descrizione

Description

Kg.

m³

Cat.

Euro



A1004 Base a 5 raggi in alluminio pressofuso

Aluminium 5 radius base

80,00

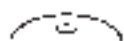

D1004 Base a disco in metallo cromato ø 53

Chromium-plated disk-base ø cm 53

110,00



D1001 Base a disco inox ø 53

Stainless steel disc base ø 53

150,00















Q1001 Base inox quadra

Stainless steel square base

160,00

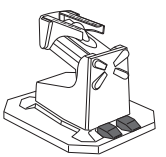
Basi per poltrone

	ART.	Descrizione	Description	Kg.	m ³	Cat.	Euro
	C1006	Colonna girevole in metallo cromato	<i>Chromium-plated metal swivel column</i>				30,00
	1012	Pompa a gas con piastra	<i>Gas pump</i>				50,00
	1010	Pompa oleodinamica cromata	<i>Chromium-plated oleodynamic pump</i>				175,00
	1011	Pompa oleodinamica con freno cromata	<i>Chromium-plated oleodynamic pump with brake</i>				245,00
	N1003	Base in nylon	<i>Nylon base</i>				20,00
	R1003	Ruote in nylon (cad.)	<i>Nylon wheel (each)</i>				3,00
	R1004	Ruote in metallo e gomma (cad.)	<i>Iron and rubber wheel (each)</i>				8,00
	C1005	Base a disco in metallo cromato ø 60	<i>Chromium-plated metal disk base ø cm 60</i>				120,00
	1008	Pompa oleodinamica con freno senza copripompa per base C1005 completo di piastra d'attacco	<i>Oleodynamic pump with brake without cover for bases C1005</i>				220,00
	C1007	Copripompa per 1008 cromato	<i>Chromium plated cover for art. 1008</i>				35,00
	1014	Basamento azionato da un attuatore e da una centralina elettronica che provvede alle funzioni di alzata e discesa; incorpora il caricabatteria e la funzione di blocco salvabatteria; alzata e discesa sono comandate da due pedali di semplice funzionamento	<i>This base works with an actuator and an electronic control box which provides all up and down movements. The battery charger and the save-battery are included. Movements are regulated by 2 easy foot pedals</i>				950,00
	E1014	Basamento 1014 con funzionamento assicurato da un trasformatore collegato ad una presa. Nel basamento arriva corrente a 12V assicurando in tale modo la sicurezza più assoluta	<i>1014 base with transformer connected to the current tap. The current arrives to the base at 12 volts and for this reason it is completely sure</i>				780,00

Zaffiro

L 57
P 160
H 48

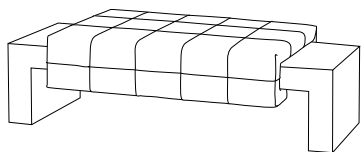

3900 Panca a due posti con struttura in legno e imbottitura in poliuretano espanso. Base in laminato nei colori di catalogo.

Description

Two seats bench with foamed polyurethane stuffing, wooded structure and laminated wood base in catalogue colours.

Kg.

m³

Cat.

Euro

A	1.320,00
B	1.290,00
C	1.250,00

Nicole K

L 52
P 60
H 87,5

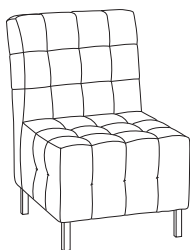

610 Poltrona d'attesa con struttura in legno e imbottitura in poliuretano espanso e basamento in metallo cromato.

Description

Chair with wood structure, stuffed with foamed polyurethane.

Kg.

m³

Cat.

Euro

A	640,00
B	630,00
C	590,00

L 122
P 60
H 87,5

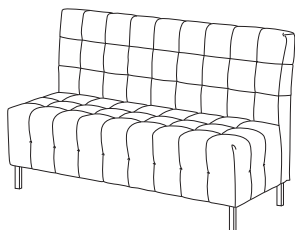

612 Divano a due posti con struttura in legno e imbottitura in poliuretano espanso e basamento in metallo cromato.

Two seats sofa with wood structure, stuffed with foamed polyurethane.

A	1.010,00
B	990,00
C	900,00

L 52
P 60
H 45

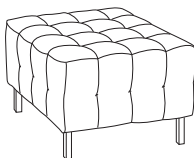

611 Puff

Puff

A	425,00
B	415,00
C	395,00

L 122
P 60
H 45

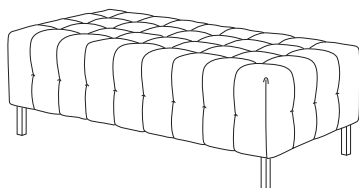

613 Puff a 2 posti

Two seat puff.

A	660,00
B	650,00
C	600,00

L 52
P 52
H 38

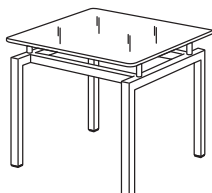

498 Tavolino in metallo cromato e piano in vetro

Chromium-plated iron table with glass top

280,00

499 Piano del tavolo in vetro laccato nei colori di catalogo



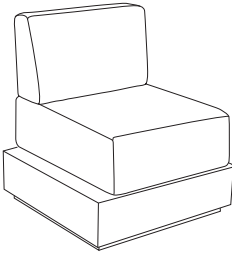
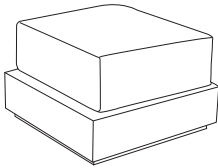
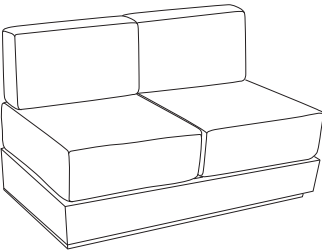
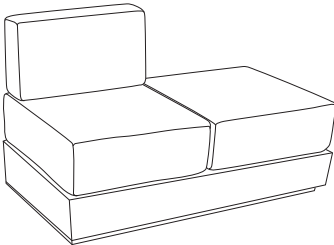
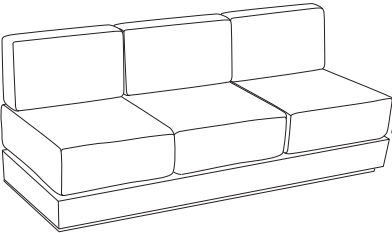

Varnished glass top. Available in catalogue colours

45,00

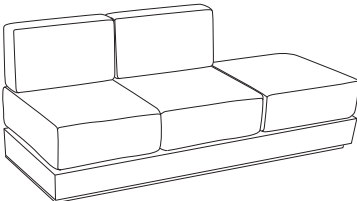
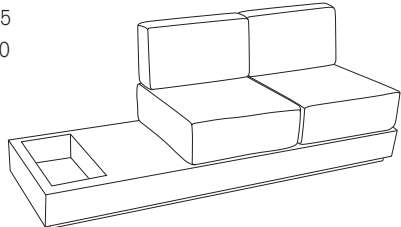
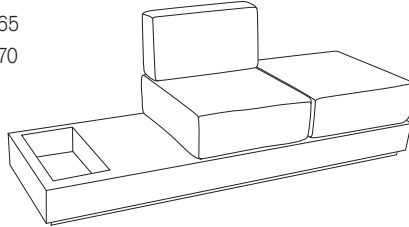

Arancio

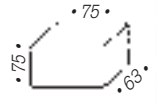
	ART.	Descrizione	Description	Kg.	m ³	Cat.	Euro
L 65 P 65 H 70		4600	Poltrona d'attesa con struttura in legno e imbottitura in poliuretano espanso. Base in legno impiallacciato rovere verniciato nei colori di catalogo.	<i>Chair with foamed polyurethane stuffing, wooded structure and veneered oak wood base varnished in catalogue colours.</i>	52	0,35	A 910,00
		4620	Poltrona d'attesa con struttura in legno e imbottitura in poliuretano espanso. Base in laminato nei colori di catalogo.	<i>Chair with foamed polyurethane stuffing, wooded structure and laminated wood base in catalogue colours.</i>			B 885,00
							C 850,00
L 65 P 65 H 45		4601	Poltrona 4600 senza schienale	<i>Chair 4600 without backrest</i>	47	0,20	A 815,00
		4621	Poltrona 4620 senza schienale	<i>Chair 4620 without backrest</i>			B 800,00
							C 785,00
L 130 P 65 H 70		4605	Divano a due posti con struttura in legno e imbottitura in poliuretano espanso. Base in legno impiallacciato rovere verniciato nei colori di catalogo.	<i>Two seats sofa with foamed polyurethane stuffing, wooded structure and veneered oak wood base varnished in catalogue colours.</i>	100	0,60	A 1.395,00
		4625	Divano a due posti con struttura in legno e imbottitura in poliuretano espanso. Base in nobilitato nei colori di catalogo.	<i>Two seats sofa with foamed polyurethane stuffing, wooded structure and laminated wood base in catalogue colours.</i>			B 1.345,00
							C 1.270,00
L 130 P 65 H 70		4606	Divano 4605 con una poltrona senza schienale	<i>Sofa 4605 with 1 chair without backrest</i>	95	0,60	A 1.300,00
		4626	Divano 4625 con una poltrona senza schienale	<i>Sofa 4625 with 1 chair without backrest</i>			B 1.260,00
							C 1.210,00
L 195 P 65 H 70		4610	Divano a 3 posti con struttura in legno e imbottitura in poliuretano espanso. Base in legno impiallacciato rovere verniciato nei colori di catalogo.	<i>3 seats sofa with foamed polyurethane stuffing, wooded structure and veneered oak wood base varnished in catalogue colours.</i>	148	0,90	A 1.980,00
		4630	Divano a 3 posti con struttura in legno e imbottitura in poliuretano espanso. Base in nobilitato nei colori di catalogo.	<i>3 seats sofa with foamed polyurethane stuffing, wooded structure and laminated wood base in catalogue colours.</i>			B 1.900,00
							C 1.790,00
						A 1.520,00	
						B 1.490,00	
						C 1.330,00	

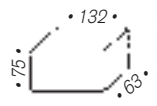
Arancio

	ART.	Descrizione	Description	Kg.	m ³	Cat.	Euro	
L 195 P 65 H 70		4611 Divano 4610 con una poltrona senza schienale	<i>Sofa 4610 with 1 chair without backrest</i>	143	0,90	A	1.880,00	
		4631 Divano 4630 con una poltrona senza schienale	<i>Sofa 4630 with 1 chair without backrest</i>	143	0,90	A	1.810,00	
						C	1.710,00	
						A	1.430,00	
						B	1.360,00	
						C	1.260,00	
L 195 P 65 H 70		4612 Divano 4610 con 2 poltrone e 1 tavolo con porta riviste	<i>Sofa 4610 with 2 chairs and 1 table with magazine holder</i>	133	0,90	A	1.800,00	
		4632 Divano 4630 con 2 poltrone e 1 tavolo con porta riviste	<i>Sofa 4630 with 2 chairs and 1 table with magazine holder</i>				A	1.750,00
						C	1.680,00	
						A	1.410,00	
						B	1.360,00	
						C	1.290,00	
L 195 P 65 H 70		4613 Divano 4610 con 2 poltrone di cui 1 senza schienale e 1 tavolo con portariviste	<i>Sofa 4610 with 2 chairs (1 without backrest) and 1 table with magazine holder</i>	128	0,90	A	1.710,00	
		4633 Divano 4630 con 2 poltrone di cui 1 senza schienale e 1 tavolo con portariviste	<i>Sofa 4630 with 2 chairs (1 without backrest) and 1 table with magazine holder</i>				A	1.670,00
						C	1.610,00	
						A	1.320,00	
						B	1.280,00	
						C	1.220,00	
Mixer relax								
	ART.	Descrizione	Description	Kg.	m ³	Cat.	Euro	
L 72 P 60 H 72		490 Poltrona d'attesa con struttura in legno multistrati (spess. 20 mm) imbottita con poliuretano espanso (40 kg/m ³)	<i>Chair with multilayered wood structure (thickness 20 mm), stuffed with foamed polyurethane (40 kg/m³)</i>	13	0,37		A	580,00
							B	550,00
						C	480,00	
L 72 P 63 H 72		491 Poltrona 490 con attacco casco	<i>Chair 490 with dryer-holder</i>	14,5	0,37		A	640,00
							B	610,00
						C	540,00	
L 129 P 60 H 72		492 Divano a due posti con struttura in legno multistrati (spess. 20 mm) rinforzata con barra metallica e imbottita con poliuretano espanso (40 kg/m ³)	<i>Two seat sofa with multilayered wood structure (thickness 20 mm) reinforced with metallic bar embossed with foamed polyurethane (40 kg/m³)</i>	28	0,63		A	860,00
							B	810,00
						C	710,00	

Mixer relax

	ART.	Descrizione	Description	Kg.	m ³	Cat.	Euro
L 129 P 63 H 72		493 Divano 492 con due attacchi casco	<i>Sofa 492 with two dryer-holder</i>	31	0,63	A	980,00
						B	930,00
						C	730,00
L 48 P 48 H 70		1200 Tavolino con portariviste, struttura in metallo verniciato e piano in cristallo	<i>Table with magazine holder. Varnished iron structure and cristal top</i>	9			180,00
L 37 H 178		1201 Attaccapanni con struttura in metallo verniciato	<i>Coat-stand with varnished iron structure</i>	7,5			210,00

Penelope

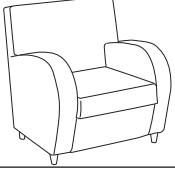
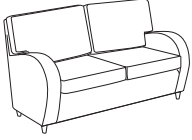
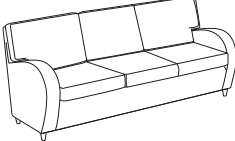
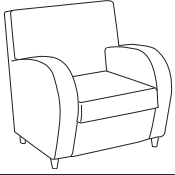
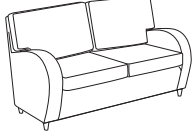
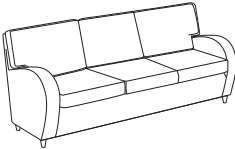
	ART.	Descrizione	Description	Kg.	m ³	Cat.	Euro
L 73 P 69 H 83		640 Poltrona d'attesa con struttura in legno e imbottitura in poliuretano espanso	<i>Chair with wood structure, stuffed with foamed polyurethane</i>	25		A	680,00
						B	620,00
						C	580,00
L 142 P 69 H 83		641 Divano a due posti con struttura in legno e imbottitura in poliuretano espanso	<i>Two seats sofa with wood structure, stuffed with foamed polyurethane</i>	40		A	940,00
						B	890,00
						C	800,00
L 202 P 69 H 83		642 Divano a tre posti con struttura in legno e imbottitura in poliuretano espanso	<i>Thre seats sofa with wood structure, stuffed with foamed polyurethane</i>	60		A	1.160,00
						B	1.080,00
						C	960,00
L 73 P 69 H 83		645 Poltrona d'attesa con struttura in legno e imbottitura in poliuretano espanso con cuscini reversibili	<i>Chair with wood structure, stuffed with foamed polyurethane with reversible cushions</i>	25		A	870,00
						B	810,00
						C	720,00
L 142 P 69 H 83		646 Divano a due posti con struttura in legno e imbottitura in poliuretano espanso con cuscini reversibili	<i>Two seats sofa with wood structure, stuffed with foamed polyurethane with reversible cushions</i>	40		A	1.230,00
						B	1.140,00
						C	980,00
L 202 P 69 H 83		647 Divano a tre posti con struttura in legno e imbottitura in poliuretano espanso con cuscini reversibili	<i>Thre seats sofa with wood structure, stuffed with foamed polyurethane with reversible cushions</i>	60		A	1.520,00
						B	1.380,00
						C	1.180,00

Beta

	ART.	Descrizione	Description	Kg.	m ³	Cat.	Euro
L 43 P 73 H 90/115	745	Questo lavatesta rappresenta una novità assoluta. La sua caratteristica è che oltre ad avere il lavabo snodato con bloccaggio manuale, si alza e si abbassa con un'escursione di 30 cm e ruota su se stesso di 340°. È interamente realizzato in acciaio zincato e la carrozzeria è realizzata in ABS.	<i>This wash unit is an absolute news. Its main specification is that in addition to the moving basin with manual stop system it also moves up and down with a difference of 30 cm and turns around itself of 340°. It is completely made in zinc-plated steel, the body is in ABS.</i>	31	0,40		1.220,00
	N745	Colonna 745 con lavello in ceramica nera	<i>Wash unit 745 with black ceramic basin</i>				1.260,00
	B745	Colonna 745 con lavello in ceramica blu	<i>Wash unit 745 with blue ceramic basin</i>				1.280,00
	746	Colonna 745 con lavello lux in ceramica bianca	<i>Wash unit 745 with white ceramic lux basin</i>	34	0,40		1.285,00
	N746	Colonna 745 con lavello lux in ceramica nera	<i>Wash unit 745 with black ceramic lux basin</i>				1.345,00
	B746	Colonna 745 con lavello lux in ceramica blu	<i>Wash unit 745 with blue ceramic lux basin</i>				1.375,00
	789	Supplemento per snodo con freno in acciaio inox	<i>Extra charge for inox steel joint with stop system</i>				25,00

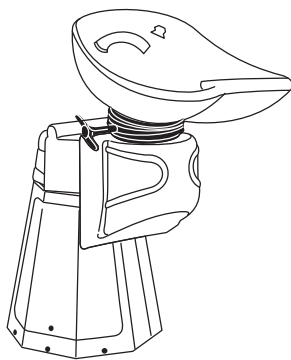

L 43
P 73
H 90/115



Archimede

	ART.	Descrizione	Description	Kg.	m ³	Cat.	Euro
L 64 P 65 H 90	735	Posto lavatesta con struttura in ferro zincato e carrozzeria in ABS regolabile in altezza (30 cm), lavello in ceramica bianca.	<i>Wash unit with zinc-plated iron structure and ABS cover. White ABS basin. It can move up and down (30 cm), with white ceramic basin.</i>	26	0,36		880,00
	N735	Colonna 735 con lavello in ceramica nero	<i>Wash unit 735 with black ceramic basin</i>				920,00
	B735	Colonna 735 con lavello in ceramica blu	<i>Wash unit 735 with blue ceramic basin</i>				940,00
	736	Colonna 735 con lavello lux in ceramica bianca	<i>Wash unit 735 with white ceramic lux basin</i>	29	0,36		945,00
	N736	Colonna 735 con lavello lux in ceramica nera	<i>Wash unit 735 with black ceramic lux basin</i>				1.005,00
	B736	Colonna 735 con lavello lux in ceramica blu	<i>Wash unit 735 with blue ceramic lux basin</i>				1.035,00
	789	Supplemento per snodo con freno in acciaio inox	<i>Extra charge for inox steel joint with stop system</i>				25,00

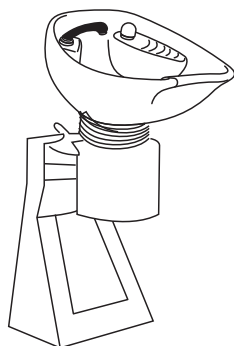

L 64
P 65
H 90



Sandalo

L 66
P 130
H 104

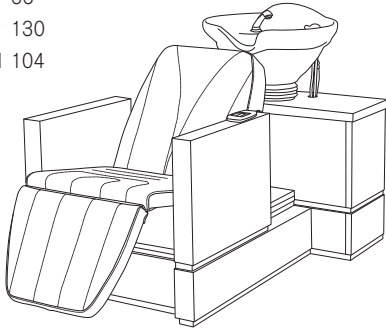



ART.	Descrizione	Description	Kg.	m ³	Cat.	Euro
4700	Posto lavatesta con struttura in legno impiallacciato rovere e verniciato nei colori di catalogo, lavello in ceramica bianca, poltrona con struttura in legno e imbottitura in poliuretano espanso, movimento assicurato da due motori elettrici alimentati dalla rete. Piano lavello in Corian®.	Wash unit with veneered oak wood structure varnished in catalogue colours. Chair with electric movements. Corian® top.	70	1,0		4.750,00
4720	Posto lavatesta realizzato con struttura in nobilitato nei colori di catalogo, lavello in ceramica bianca, poltrona con struttura in legno e imbottitura in poliuretano espanso, movimento assicurato da due motori elettrici alimentati dalla rete. Piano lavello in Corian®.	Wash unit with laminated wood structure in catalogue colours. Chair with powered base and white ceramic basin. Corian® top	80	1,0		3.850,00
4708	Supplemento per lavello nero	Extra-charge for black basin				60,00
4709	Supplemento per lavello blu	Extra-charge for blue basin				90,00
4701	Supplemento per massaggio a vibrazione	Extra-charge for vibrating massage				180,00
4702	Supplemento per massaggio schiena e a vibrazione	Extra-charge for back massage and vibrating massage	5			480,00
789	Supplemento per snodo con freno in acciaio inox	Extra charge for inox steel joint with stop system				25,00



Idraulica

ART.	Descrizione	Description	Kg.	m ³	Cat.	Euro
1100	Lavello in ceramica bianco	White ceramic wash basin				160,00
1103	Lavello in ceramica nero	Black ceramic wash basin				200,00
1104	Lavello in ceramica blu	Blue ceramic wash basin				220,00
1105	Lavello lux in ceramica bianco	White ceramic lux wash basin				220,00
1106	Lavello lux in ceramica nero	Black ceramic lux wash basin				280,00
1107	Lavello lux in ceramica blu	Blue ceramic lux wash basin				310,00
1122	Snodo universale in metallo verniciato con bloccaggio manuale e coprisnodo in gomma EPDM	Universal joint in varnished metal with manual stop system and cover in EPDM rubber				60,00
1124	Snodo 1122 in acciaio inox	Stainless steel joint 1122				85,00
1123	Snodo 1122 con frizione	Joint 1122 with clutch				55,00
1125	Snodo 1122 in acciaio inox con frizione	Stainless steel joint 1122 with clutch				80,00
1150	Gruppo miscelatore monocomando completo di tubi flessibili	Monocontrol mixing unit with flexible pipes				65,00

Idraulica

	ART.	Descrizione	Description	Kg.	m ³	Cat.	Euro
	1151	Sfera, gruppo miscelatore monocomando completo di tubi flessibili	Sfera, monocontrol mixing unit with flexible pipes				65,00
	1154	Flessibile per doccia	Shower flexible pipe				45,00
	1157	Portadocchetta	Shower holder				
	1158	Docchetta	Shower				
	1159	Piletta con scarico flessibile per lavello	Drain with flexible pipe for wash basin				15,00
	1161	Piletta con scarico flessibile per lavello lux	Drain with flexible pipe for lux wash basin				20,00

Perla

L 60
P 15
H 200

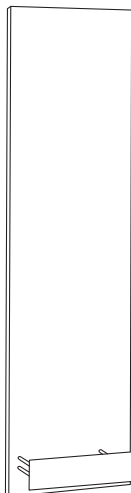

	ART.	Descrizione	Description	Kg.	m ³	Cat.	Euro
	860	Posto di lavoro con telaio in alluminio e specchio con integrato poggiapiedi in acciaio inox.	Styling unit with aluminium structure and mirror with inox steel footrest.				630,00
	861	Supplemento per illuminazione retro specchio	Extra-charge for mirror light				120,00

Luce

L 50
P 25
H 190

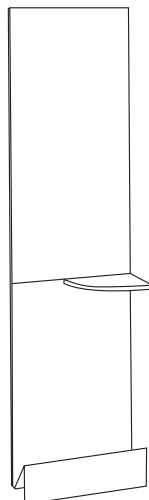

	ART.	Descrizione	Description	Kg.	m ³	Cat.	Euro
	839	Posto di lavoro con telaio in acciaio inox satinato e specchio sabbato, piano d'appoggio con telaio in acciaio inox e cristallo verniciato nei colori di catalogo con integrato poggiapiedi in acciaio inox.	Styling unit with glazed stainless steel structure, sandblasted mirror. Top with stainless steel structure and varnished crystal, available in all catalogue colours with inox steel footrest.				525,00
	P839	Portaphon	Dryer-holder				25,00

Biancospino

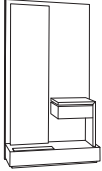
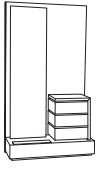
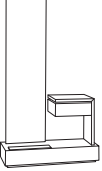
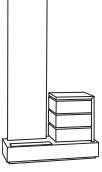
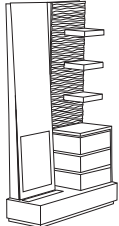
		ART.	Descrizione	Description	Kg.	m ³	Cat.	Euro
L 40 P 115 H 200		4801	Posto di lavoro 4800 con 1 cassetto	<i>Styling unit 4800 with 1 drawer.</i>	90	0,95		2.350,00
		4821	Posto di lavoro 4820 con 1 cassetto	<i>Styling unit 4820 with 1 drawer.</i>				1.780,00
L 40 P 115 H 200		4802	Posto di lavoro 4800 con 3 cassetto	<i>Styling unit 4800 with 3 drawer.</i>	100	0,95		2.540,00
		4822	Posto di lavoro 4820 con 3 cassetto	<i>Styling unit 4820 with 3 drawer.</i>				1.910,00
L 40 P 115 H 200		4811	Posto di lavoro 4800 senza pannello	<i>Styling unit 4800 without back board.</i>	80	0,95		2.190,00
		4831	Posto di lavoro 4820 senza pannello	<i>Styling unit 4820 without back board.</i>				1.660,00
L 40 P 115 H 200		4812	Posto di lavoro 4800 senza pannello	<i>Styling unit 4800 without back board.</i>	90	0,95		2.380,00
		4832	Posto di lavoro 4820 senza pannello	<i>Styling unit 4820 without back board.</i>				1.790,00
	4809	Supplemento per specchio sabbato	<i>Extra charge for sandblasted mirror</i>					50,00
	4819	Supplemento per mensole in vetro (3) 35x15 cm	<i>Extra charge for glass shelves (3) 35x15 cm</i>					135,00
	4818	Supplemento per mensole in legno (3) 35x23 cm e rivestimento in MDF colorato	<i>Extra charge for wood shelves (3) 35x23 cm and coloured MDF cover</i>					240,00

Giada

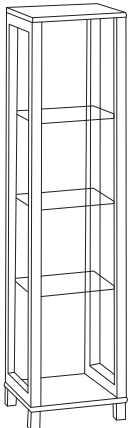
		ART.	Descrizione	Description	Kg.	m ³	Cat.	Euro
L 40 P 40 H 160		2100	Vetrina per esposizione in legno massello.	<i>Vetrine made in massive wood.</i>	20	0,30		670,00
		2101	Vetrina per esposizione in legno massello con anta in vetro.	<i>Vetrine made in massive wood with glass door.</i>	24	0,30		790,00
		A2100	Anta in vetro	<i>Glass door</i>				120,00
		983	Supplemento per serratura	<i>Extra charge for lock</i>				25,00
		E956	Lampada per Giada	<i>Giada lamp</i>				50,00

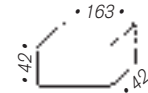

Zenzero

	ART.	Descrizione	Description	Kg.	m ³	Cat.	Euro
L 45 P 40 H 200	4950	Mobile con cassetto, ripiano porta borsa e pannello di sostegno con 2 mensole. Struttura in legno impiallacciato rovere verniciato nei colori di catalogo.	Consolle with drawer, bag shelf and back board with 2 shelves. Veneered oak wood structure, varnished in catalogue colours.	25	0,40		1.150,00
	4952	Mobile 4950 realizzato in nobilitato nei colori di catalogo.	Consolle 4950 with laminated wood structure in catalogue colours.				810,00
	4951	Mobile 4950 sospeso, senza pannello di sostegno e mensole.	Consolle 4950 without back board and 2 shelves.	18	0,15		780,00
L 40 P 40 H 80	4953	Mobile 4951 realizzato in nobilitato nei colori di catalogo.	Consolle 4951 with laminated wood structure in catalogue colours.				550,00

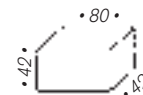
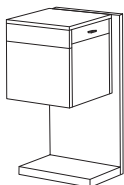
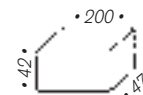
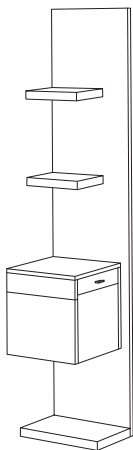

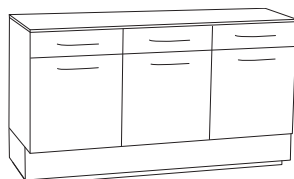
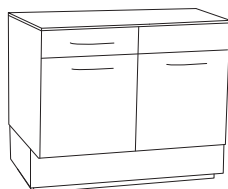
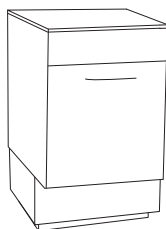

Sesamo

	ART.	Descrizione	Description	Kg.	m ³	Cat.	Euro
L 45 P 45/55 H 77/87	4920	Mobile base da cm 45 con struttura in legno impiallacciato rovere e verniciato nei colori di catalogo.	Base consolle (45 cm) with veneered oak wood structure varnished in catalogue colours.	50	0,20		1.010,00
	4925	Mobile base da cm 45 con struttura in nobilitato nei colori di catalogo.	Base consolle (45 cm) with laminated wood structure in catalogue colours.				760,00
	4930	Supplemento per ripiano in vetro nei colori di catalogo (45 cm).	Extra charge for cristal top in catalogue colours (45 cm).				60,00
L 90 P 45/55 H 77/87	4921	Mobile 4920 da cm 90	Consolle 4920 (90 cm).	85	0,40		1.550,00
	4926	Mobile 4925 da cm 90	Consolle 4925 (90 cm).				1.080,00
	4931	Supplemento per ripiano in vetro nei colori di catalogo (90 cm).	Extra charge for cristal top in catalogue colours (90 cm).				120,00
L 135 P 45/55 H 77/87	4922	Mobile 4920 da cm 135	Consolle 4920 (135 cm).	110	0,60		2.090,00
	4927	Mobile 4925 da cm 135	Consolle 4925 (135 cm).				1.410,00
	4932	Supplemento per ripiano in vetro nei colori di catalogo (135 cm).	Extra charge for cristal top in catalogue colours (135 cm).				170,00



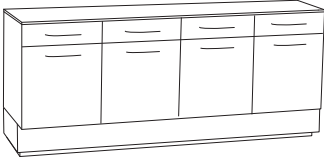
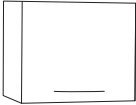
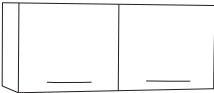
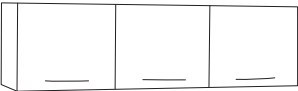





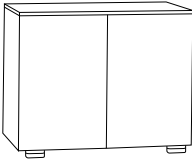
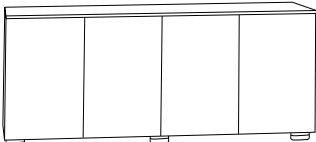

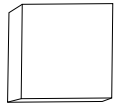
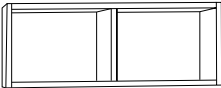
Sesamo

	ART.	Descrizione	Description	Kg.	m ³	Cat.	Euro
L 180 P 45/55 H 77/87		4923 Mobile 4920 da cm 180	Consolle 4920 (180 cm).	140	0,85		2.630,00
		4928 Mobile 4925 da cm 180	Consolle 4925 (180 cm).				1.730,00
		4933 Supplemento per ripiano in vetro nei colori di catalogo (180 cm).	Extra charge for cristal top in catalogue colours (180 cm).				230,00
L 45 P 35 H 45		4910 Mobile sospeso da cm 45 con struttura in legno impiallacciato rovere e verniciato nei colori di catalogo.	Consolle (45 cm) with veneered oak wood structure varnished in catalogue colours.	20	0,09		660,00
		4915 Mobile sospeso da cm 45 con struttura in nobilitato nei colori di catalogo.	Consolle (45 cm) with laminated wood structure in catalogue colours.				460,00
L 90 P 35 H 45		4911 Mobile 4910 da cm 90.	Consolle 4910 (90 cm).	40	0,18		1.070,00
		4916 Mobile 4915 da cm 90.	Consolle 4915 (90 cm).				670,00
L 135 P 35 H 45		4912 Mobile 4910 da cm 135.	Consolle 4910 (135 cm).	60	0,27		1.480,00
		4917 Mobile 4915 da cm 135.	Consolle 4915 (135 cm).				880,00
L 180 P 35 H 45		4913 Mobile 4910 da cm 180.	Consolle 4910 (180 cm).	80	0,35		1.890,00
		4918 Mobile 4915 da cm 180.	Consolle 4915 (180 cm).				1.090,00

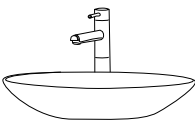
Iris

	ART.	Descrizione	Description	Kg.	m ³	Cat.	Euro
L 100 P 45 H 78		3910 Mobile base da cm 100 con struttura in nobilitato nei colori di catalogo	Base consolle (100 cm) with laminated wood structure in catalogue colours				840,00
L 200 P 45 H 78		3912 Mobile base da cm 200 con struttura in nobilitato nei colori di catalogo	Base consolle (200 cm) with laminated wood structure in catalogue colours				1.590,00

Iris		ART.	Descrizione	Description	Kg.	m ³	Cat.	Euro
L 40 P 39 H 40		3920	Mobile sospeso da cm 40 con struttura in nobilitato nei colori di catalogo.	Consolle (40 cm) with laminated wood structure in catalogue colours.				390,00
L 80 P 30 H 30		3925	Mobile a giorno sospeso da cm 80 con struttura in nobilitato nei colori di catalogo.	Consolle (80 cm) with laminated wood structure in catalogue colours.				350,00
		T4940	Kit per taniche (su mobile da 90/135/180)	Kit for water tanks (90/135/180 consolle)				220,00
		T4941	Kit per taniche riscaldate (su mobile da 90/135/180)	Kit for warming water tanks (90/135/180 consolle)				630,00
		4936	Supplemento per lavello in ceramica bianca in appoggio.	Extra charge for white ceramic bench basin.				660,00
		4937	Supplemento per lavello in ceramica colorata in appoggio.	Extra charge for coloured ceramic bench basin.				780,00
		4938	Supplemento per lavello in ceramica oro o mercurio in appoggio.	Extra charge for gold or mercury ceramic bench basin.				990,00
		3915	Supplemento per lavello in ceramica bianca in appoggio (tondo)	Extra charge for white ceramic bench basin (round)				470,00
		3916	Supplemento per lavello in ceramica bianca in appoggio (grande)	Extra charge for white ceramic bench basin (large)				610,00
		3917	Supplemento rubinetto serie "I gioielli di Visentin"	Extra charge mixer tap "I gioielli di Visentin"				360,00
		4939	Supplemento per lavello in acciaio ad incasso e miscelatore con doccia estraibile (3 mt).	Extra charge for steel inset basin and mixer with extractable handshower (3m flexible).				700,00
		L4939	Supplemento per lavello ø38 cm + miscelatore + piletta	Extra charge for steel basin ø38 cm + mixer + flexible pipe				470,00
		P4939	Supplemento per lavello ø30 cm + miscelatore + piletta	Extra charge for steel basin ø30 cm + mixer + flexible pipe				430,00
Sesamo		ART.	Descrizione	Description	Kg.	m ³	Cat.	Euro
L 80 P 40 H 195		4902	Mobile espositore grande con 2 colonne con struttura in legno impiallacciato rovere e verniciato nei colori di catalogo (cm 115).	Two columns large display stand with veneered oak wood structure varnished in catalogue colours (cm 115).	60	0,70		1.890,00
		4907	Mobile espositore grande con 2 colonne con struttura in nobilitato nei colori di catalogo (cm 115).	Two columns large display stand with laminated wood structure in catalogue colours (cm 115).	60	0,70		1.390,00

Iris drink

L 50
P 50
H 70

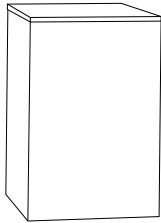

ART.	Descrizione	Description	Kg.	m ³	Cat.	Euro
3911	Mobile su ruote con frigorifero silenzioso con struttura in nobilitato nei colori di catalogo	<i>Trolley with silent refrigerator with laminated wood structure in catalogue colours</i>				1.360,00

Gemma

L 175
P 88
H 110

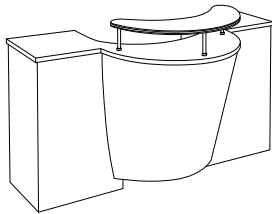

ART.	Descrizione	Description	Kg.	m ³	Cat.	Euro
3905	Mobile per cassa con struttura in nobilitato nei colori di catalogo, piano in cristallo	<i>Reception desk with laminated wood structure in catalogue's colours and cristal top</i>				1.890,00

Mirra

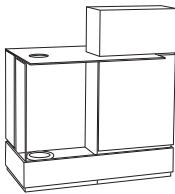

ART.	Descrizione	Description	Kg.	m ³	Cat.	Euro
4400	Mobile per cassa con struttura in legno impiallacciato rovere verniciato nei colori di catalogo, piano in cristallo sabbato (110 cm).	<i>Reception desk with veneered oak wood structure varnished in catalogue's colours and sandblasted cristal top (110 cm).</i>				2.600,00
4405	Mobile per cassa con struttura in nobilitato nei colori di catalogo, piano in cristallo sabbato (110 cm).	<i>Reception desk with laminated wood structure in catalogue's colours and sandblasted cristal top (110 cm).</i>				2.000,00

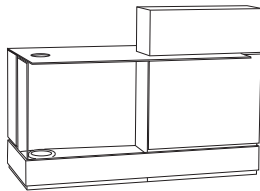



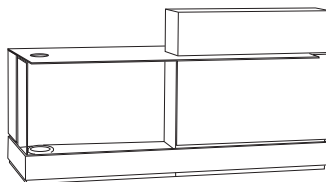



4401	Mobile per cassa con struttura in legno impiallacciato rovere verniciato nei colori di catalogo, piano in cristallo sabbato (150 cm).	<i>Reception desk with veneered oak wood structure varnished in catalogue's colours and sandblasted cristal top (150 cm).</i>				3.200,00
4406	Mobile per cassa con struttura in nobilitato nei colori di catalogo, piano in cristallo sabbato (150 cm).	<i>Reception desk with laminated wood structure in catalogue's colours and sandblasted cristal top (150 cm).</i>				2.450,00



4402	Mobile per cassa con struttura in legno impiallacciato rovere verniciato nei colori di catalogo, piano in cristallo sabbato (200 cm).	<i>Reception desk with veneered oak wood structure varnished in catalogue's colours and sandblasted cristal top (200 cm).</i>				3.800,00
4407	Mobile per cassa con struttura in nobilitato nei colori di catalogo, piano in cristallo sabbato (200 cm).	<i>Reception desk with laminated wood structure in catalogue's colours and sandblasted cristal top (200 cm).</i>				2.900,00

Sgabelli

	ART.	Descrizione	Description	Kg.	m ³	Cat.	Euro
L 33 P 33 H 60		811 Sgabello regolabile con pompa a gas alta e sedile imbottito	<i>Stool with long gas pump and stuffed seat</i>	7			145,00
	B811	Sgabello regolabile con pompa a gas bassa e sedile imbottito	<i>Stool with short gas pump and stuffed seat</i>				125,00
L 33 P 33 H 80		812 Sgabello 811 con schienale	<i>Stool 811 with back-rest</i>	11			180,00
	B812	Sgabello 812 con pompa bassa	<i>Stool 812 with short pump</i>				160,00
L 33 P 33 H 60		813 Sgabello regolabile con pompa a gas alta, sedile in skay imbottito con poliuretano espanso (40 kg/m ³) con base nera e ruote in abs	<i>Stool with long gas pump, stuffed seat with foamed polyurethane (40 kg/m³) covered with skay with ABS base and wheels</i>	8,5		B	185,00
	B813	Sgabello 813 con pompa bassa	<i>Stool 813 with short pump</i>			C	175,00
						B	165,00
						C	155,00
L 33 P 33 H 84		814 Sgabello regolabile con pompa a gas, sedile e schienale in skay imbottito con poliuretano espanso (40 kg/m ³) con base nera e ruote in abs	<i>Stool with gas pump, stuffed seat and backrest with foamed polyurethane (40 kg/m³) covered with skay with ABS base and wheels</i>	13		B	235,00
	B814	Sgabello 814 con pompa bassa	<i>Stool 814 with short pump</i>			C	225,00
						B	215,00
						C	205,00
L 41 P 41 H 91		819 Sgabello regolabile con pompa a gas, sedile in legno imbottito con poliuretano (40kg/m ³) e rivestito in skay, schienale nei colori di catalogo	<i>Stool with gas pump, seat made of wood, embossed with foamed polyurethane (40kg/m³) and covered with skay. The backrest is available in all catalogue colours</i>	8,5		B	160,00
						C	150,00
L 43 P 40 H 73		3820 Sgabello con struttura in acciaio interamente schiumato in poliuretano integrale "FREE FORM". Disponibile in 7 colori. Base e ruote in poliammide FV. Pompa a gas alta.	<i>Stool with steel structure foamed polyurethane in "FREE FORM" integral skin, available in 7 colours. Polyamide FV base and wheels. Long gas pump.</i>	11			330,00
	B3820	Sgabello 3820 con pompa bassa	<i>Stool 3820 with short pump</i>				310,00
		3821 Supplemento per base in alluminio e ruote in metallo e gomma.	<i>Extra-charge for Aluminium base with metal and rubber wheels.</i>				85,00
L 45 P 26 H 27		1203 Seduta per bimbi con protezione per i piedi e allaccio di sicurezza, imbottita con poliuretano espanso (40 kg/m ³)	<i>Children seat with protection for feet and safety lacing, stuffed with foamed polyurethane (40 kg/m³)</i>	1,6		B	120,00
						C	100,00

Condizioni di vendita

- 1) Le commissioni dovranno essere trasmesse per iscritto e la Casa le riterrà vincolanti solo se espressamente accettate. Evaderemo anche ordini telefonici, ma, in mancanza di una conferma scritta tempestiva, non ci riterremo responsabili di errori di fornitura a qualsiasi causa imputabili.
- 2) La merce viaggia a rischio e pericolo del committente anche se venduta franco destino.
In caso di consegna pattuita franco cantiere o magazzino del Cliente, la consegna della merce si intenderà da effettuarsi all'ingresso del cantiere o magazzino e la presa dei colli dovrà essere effettuata a cura e con i mezzi del Cliente a bordo automezzo.
- 3) Eventuali danneggiamenti agli imballaggi della merce dovranno essere immediatamente contestati dal Cliente al vettore mediante annotazione specifica sulla bolla di presa in consegna: in difetto di contestazione scritta la merce si intende ricevuta in perfette condizioni.
- 4) Il cliente prende atto che i colori e le altre caratteristiche qualitative della merce possono differire dai Campionari e tra partite diverse nei limiti di normale tollerabilità: la Casa non assume responsabilità al riguardo.
- 5) Eventuali difetti o vizi della merce dovranno essere denunciati alla Casa, in forma scritta, a mezzo di raccomandata spedita entro otto giorni dal ricevimento della merce (se si tratti di vizi manifesti) o alla scoperta (se si tratta di vizi occulti).
- 6) In caso di contestazione, la Casa si riserva il diritto di chiedere per iscritto la restituzione della merce per provvedere, quindi, alla sua sostituzione: in tale eventualità il Cliente dovrà effettuare la restituzione entro 15 giorni dal ricevimento della comunicazione a pena decadenza del reclamo. La sostituzione della merce comporterà l'esonero della Casa da qualsiasi altra responsabilità.
- 7) I Listini e i Campionari non costituiscono per la Casa impegno alla disponibilità della merce che dovrà, quindi, essere confermata di volta in volta all'atto dell'accettazione della commissione.
Per esigenze tecniche di funzionalità e di estetica la ditta costruttrice e venditrice può in qualsiasi momento (senza l'obbligo di avvisare la committente) apportare modifiche agli articoli esposti sul catalogo generale.
- 8) In ogni caso di mancata o ritardata consegna della merce ovvero di mancanza di qualità o vizi la Casa, indipendentemente dalla operatività delle altre clausole delle presenti condizioni di vendita non sarà comunque tenuta ad un risarcimento del danno superiore al 10% del valore della merce in contestazione.
- 9) Le fatture dovranno essere pagate presso la nostra sede nei termini convenuti senza sconti ed abbuoni. Sarà comunque facoltà della Casa di emettere tratte o ricevute bancarie al cliente, anche se non specificatamente pattuite. Le spese di incasso saranno comunque a carico del cliente.
- 10) Eventuali ritardi dei pagamenti comporteranno a carico del cliente la perdita di ogni sconto, se pattuito, e l'addebito degli interessi di mora calcolati ad un tasso superiore del 5% al tasso Ufficiale di sconto della BCE.
- 11) Per ogni insoluto o per ogni pratica di ritardato pagamento sarà addebitata una cifra fissa forfettaria per spese di segreteria.
- 12) Con l'accettazione delle presenti "Condizioni generali di vendita" il Cliente rinuncia alla efficacia delle sue eventuali "Condizioni generali di acquisto".
- 13) Per ogni controversia è competente l'autorità giudiziaria di Cremona.

Spese accessorie

- A) Merce resa franco fabbrica.
- B) Spese incasso RIBA cadauna e 5,00. (solo incassi Italia).
- C) Spese di segreteria per ogni insoluto e 12,00.

Generale Terms of sale

- 1) Orders must be transmitted written and will be considered bound only if expressly accepted.
- 2) Goods travel at customer's risk, even if sold free of destination. In the particular case of delivery free yard or free customer's storehouse, goods will be delivered at the entrance of the storehouse and all parcels must be collected by the customers on the trucks.
- 3) Any possible damage of goods packing must be immediately contested by the customer to the driver by a specific note on the delivery note: in other case, goods will be considered received in perfect conditions.
- 4) Colours and other quality characteristics of goods may be different from samples and between different lots in the limits of normal allowance: the company doesn't assume any responsibility.
- 5) Any quality defect or vice of goods must be immediately reported to the company with a registered letter, posted within 8 days from the receiving of goods (for manifest vices) or from the discovery (for hidden vices).
- 6) In any case of contest the company has the right to ask to return the goods to be changed. In this case the customer must return the goods within 15 days from the receiving of the communication, in the contrary case the complaint will be rejected. With the changing of goods the company has no more responsibility.
- 7) Price-list and sample books don't blind the company to have goods availability which will be confirmed each time at the acceptance of order. The company is free to modify at any time the items presented on the leaflet, owing to any technical reason or aesthetical improvements without giving notice to the buyer.
- 8) In any case of late or non-delivery of goods or for want of quality and vices, independently from all these terms of sale, the company is not bound to pay an indemnity superior to the 10% of the value of the contested goods.
- 9) All invoices must be paid at our seat at the agreed terms without discount or allowances. In any case the company has the faculty to issue a bill even if not precisely stated.
All costs of the collection will be at the customer's charge.
- 10) Possible delays of payment will cause for the customer the loss of any discount if agreed, and the charge of interest on delayed calculated in an annual rate superior to the 5% of the Official discount rate of the "BCE".
- 11) For any unpaid or for any delayed payment, the customer will be charged with a fixed amount of money for secretariat costs.
- 12) With the acceptance of these "general terms of sale" the customer releases to his eventual "general terms of purchase".
- 13) In case of any controversy the court of Cremona is the only competent.

Additional Charges

- A) Goods are always delivered ex-work.

CASTING s.r.l.
Località Fornace, 1 26020 Crotta d'Adda (CR) Italy
Tel. +39 0372 722622 Fax +39 0372 721133
www.casting-srl.com info@casting-srl.com

